



**EVOTECH**®  
P E R F O R M A N C E

[www.evotech-performance.com](http://www.evotech-performance.com)

Suzuki V-Strom 650

Ultimateaddons Sat Nav Mount



## Kit Contents PRN014569-015151

- Ⓐ 1 x Main Plate
- Ⓑ 1 x Pivot Plate
- Ⓒ 1 x Sub Mounting Bracket
- Ⓓ 2 x M5 x 8mm Black Button Head Bolts
- Ⓔ 2 x P-clips (No.1)
- Ⓕ 2 x P-clips (No.2)
- Ⓖ 2 x P-clips (No.3)
- Ⓗ 2 x P-clips (No.4)
- Ⓘ 2 x Lobe Screw
- Ⓙ 2 x M5 Black Washer
- Ⓚ 2 x Locking Washer
- Ⓛ 2 x M4 x 5mm Black Button Head Bolts

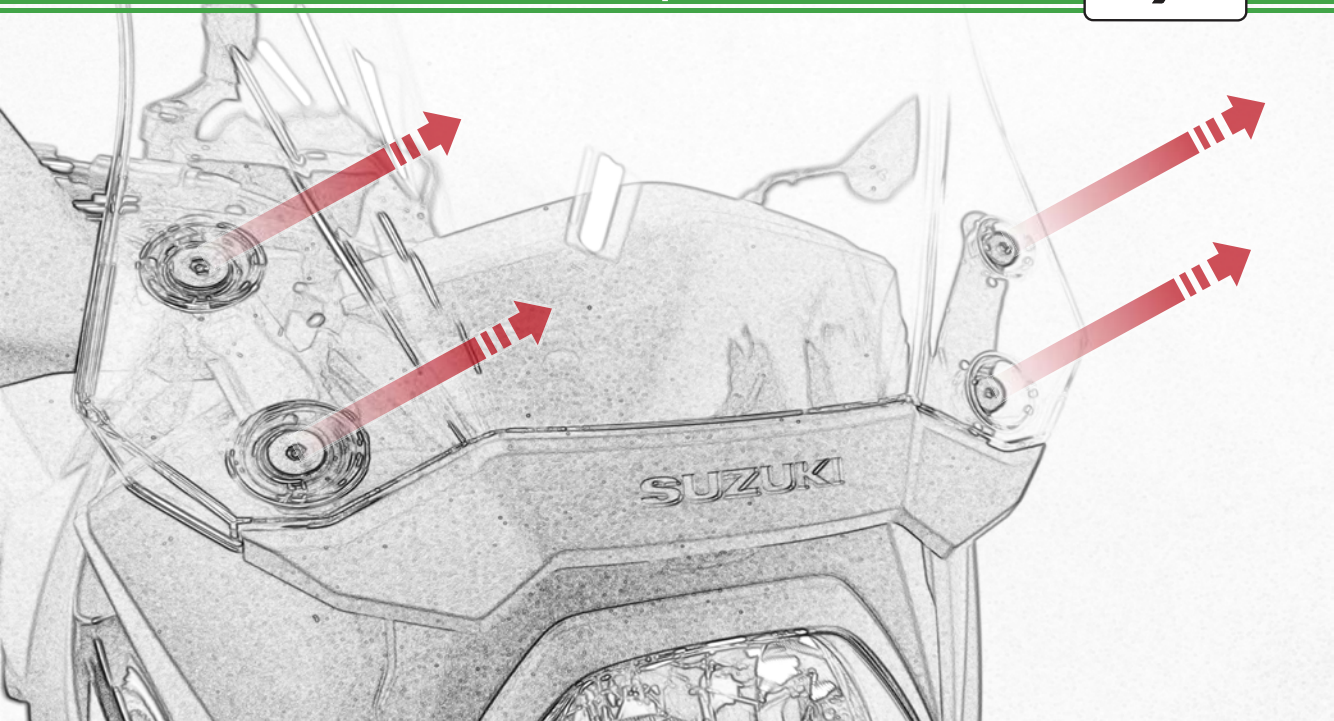

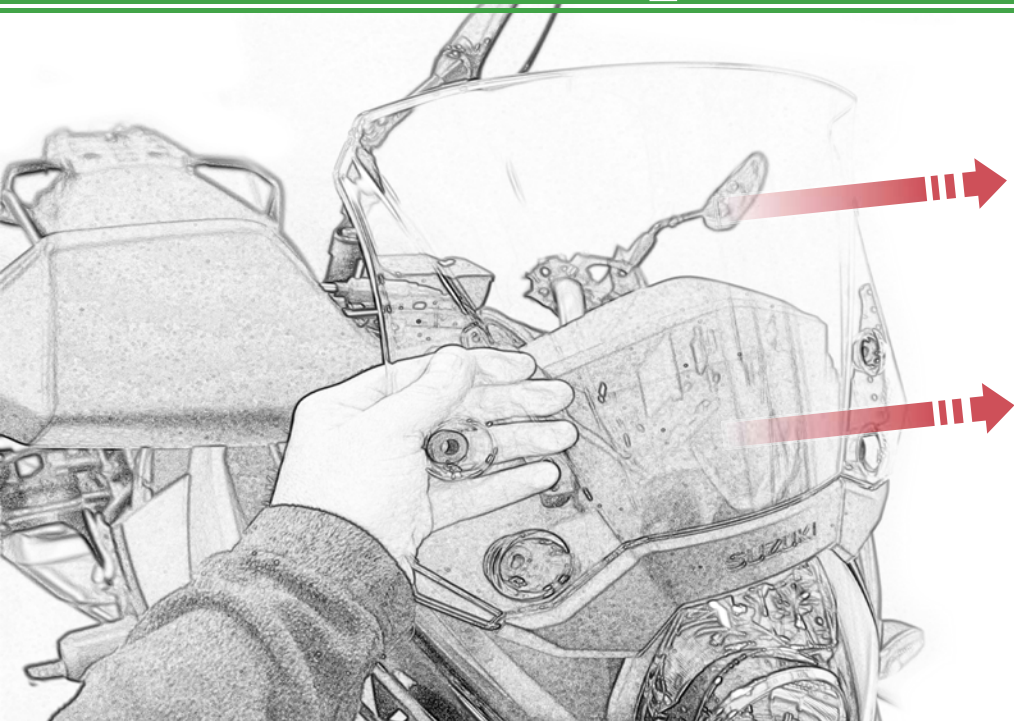

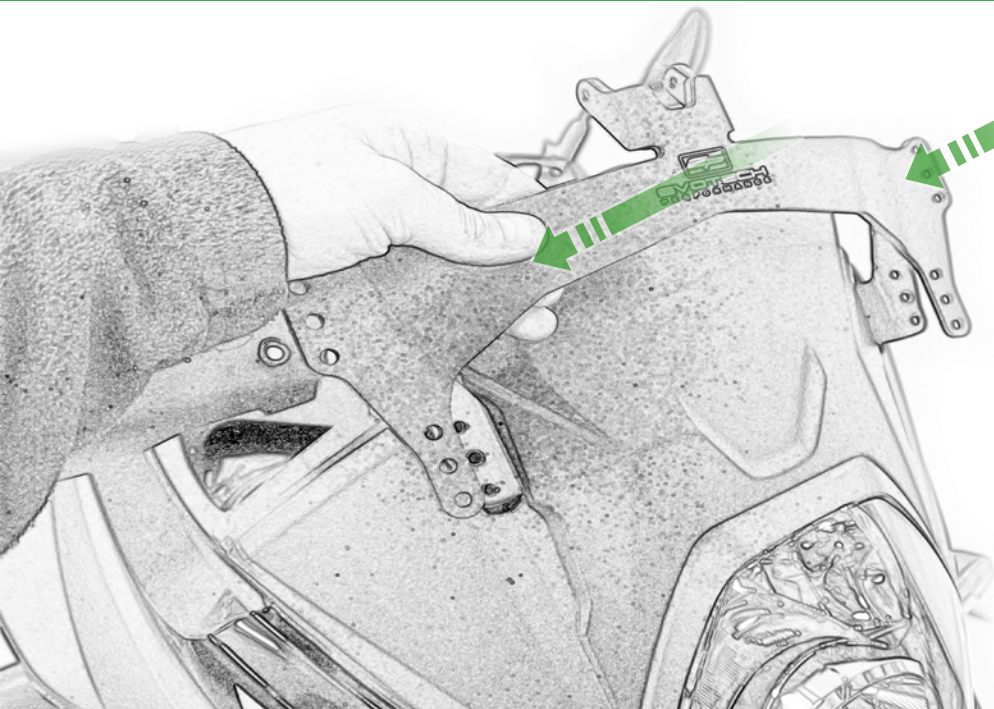

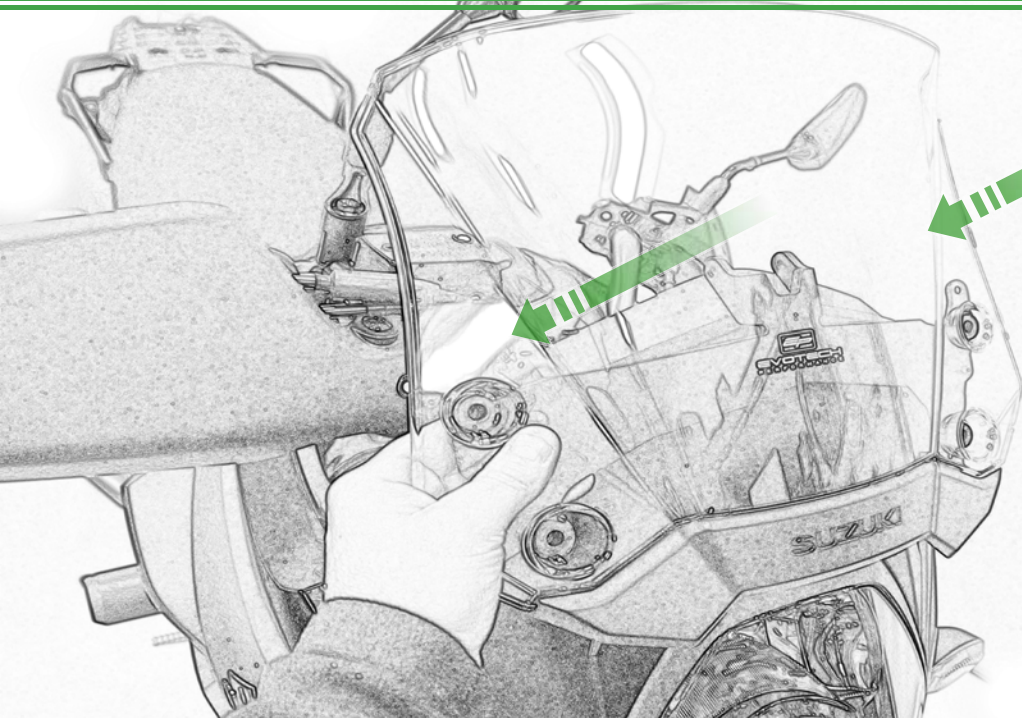

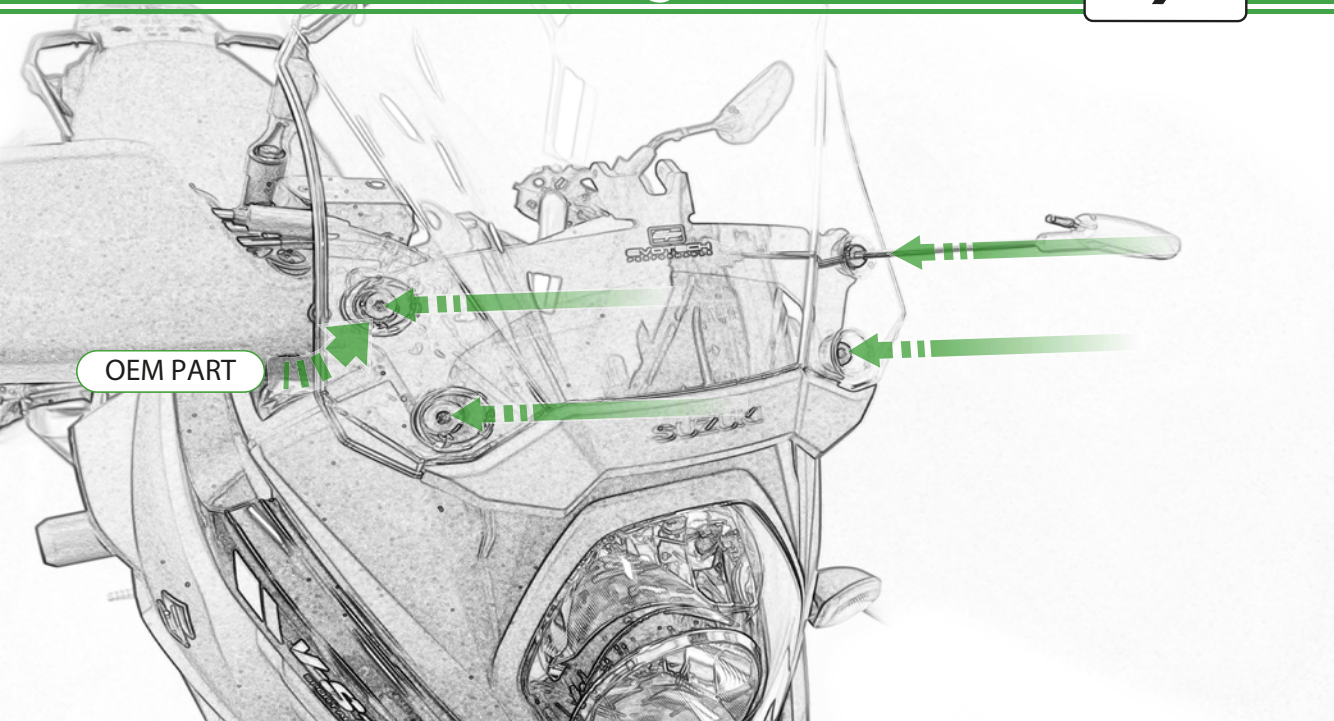

OEM PART

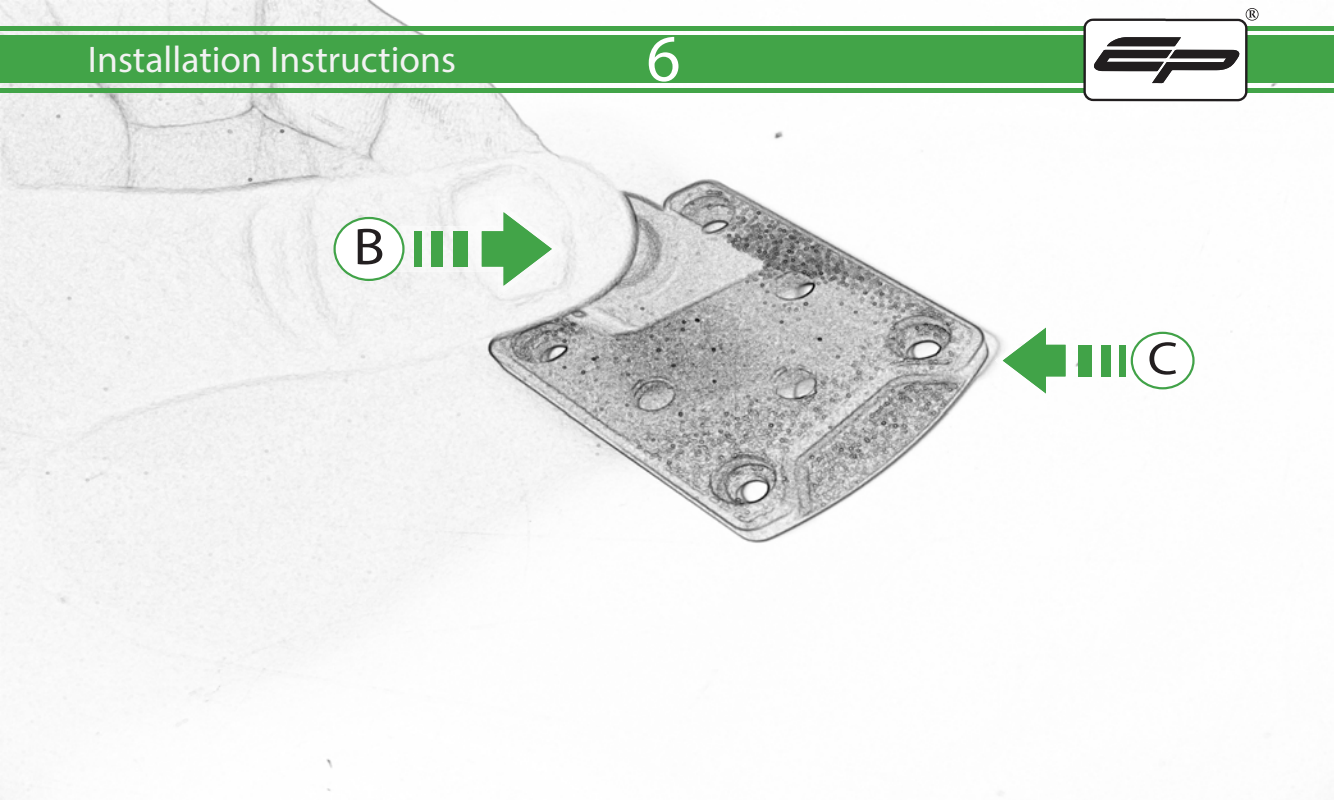



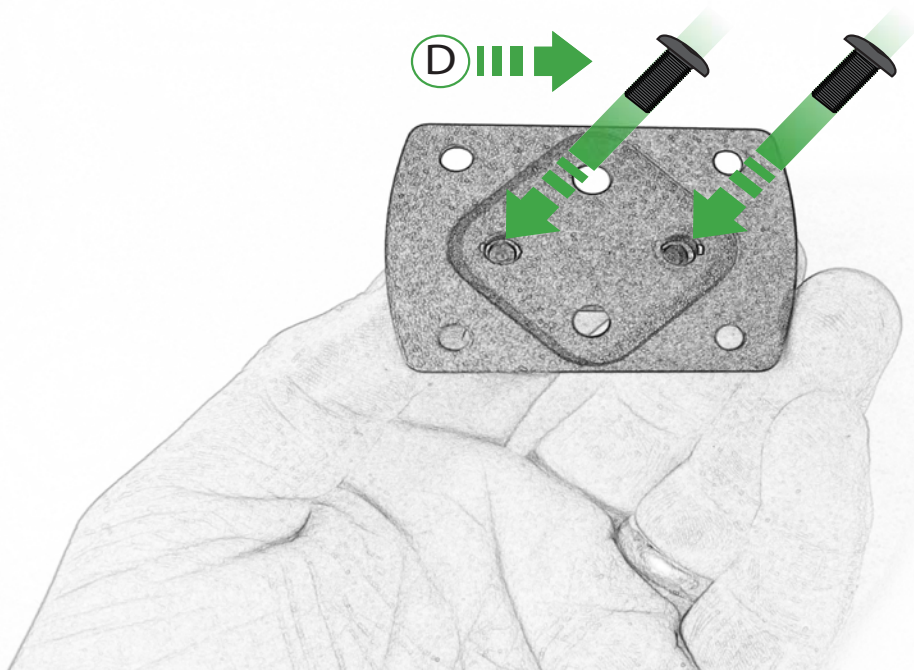

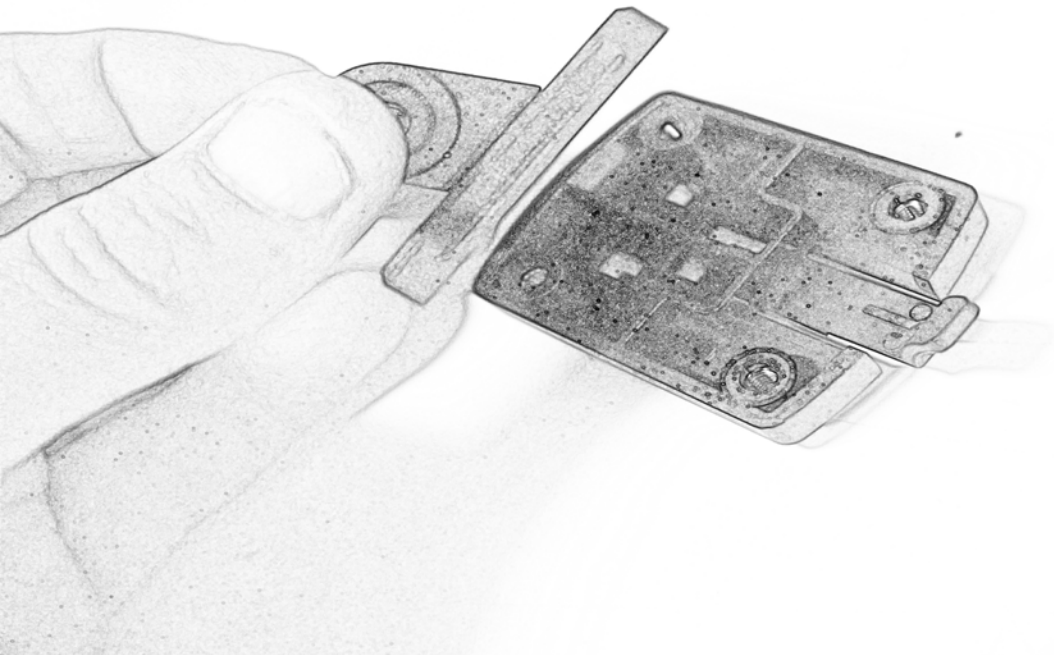



OEM PART

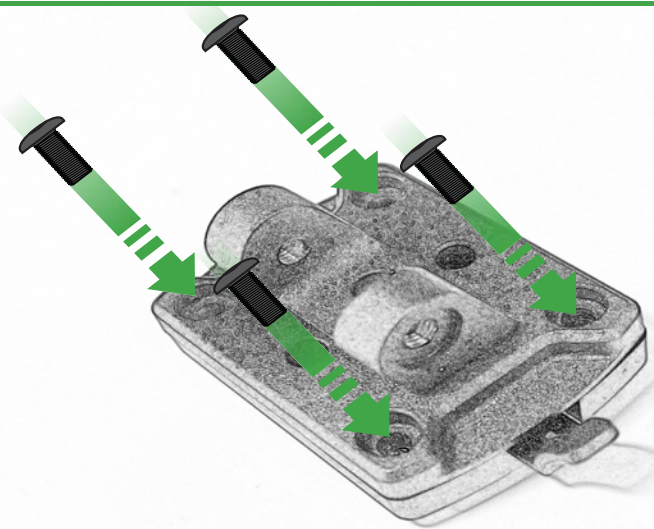

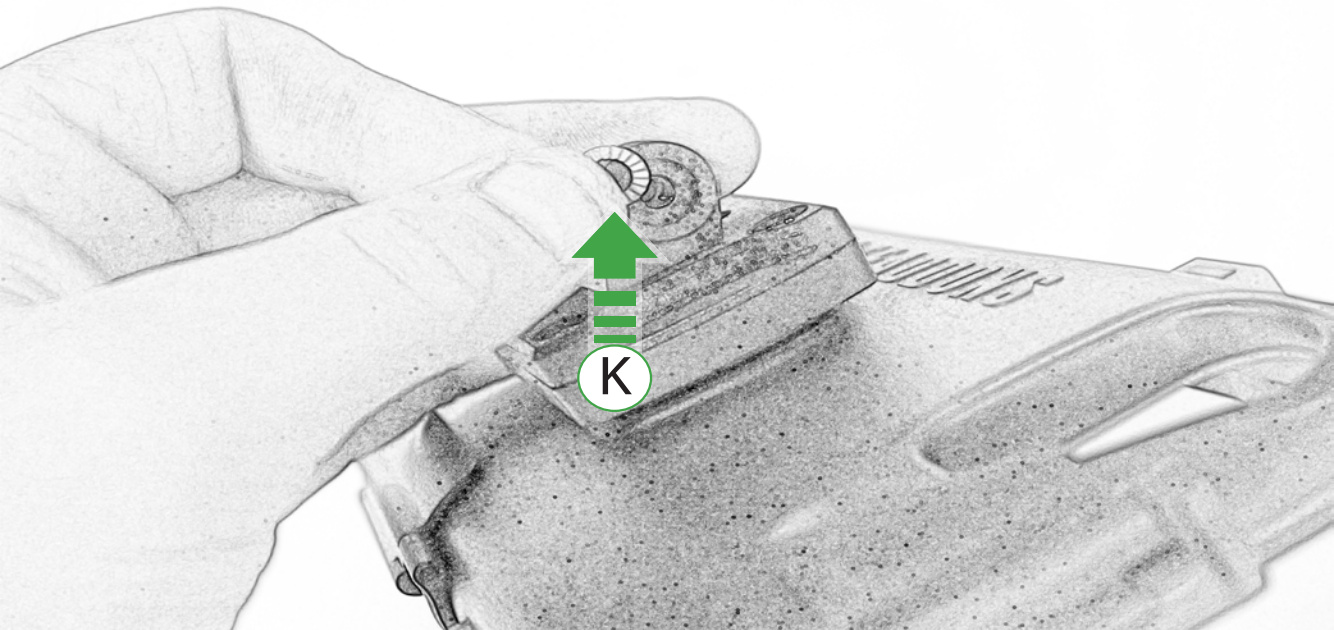

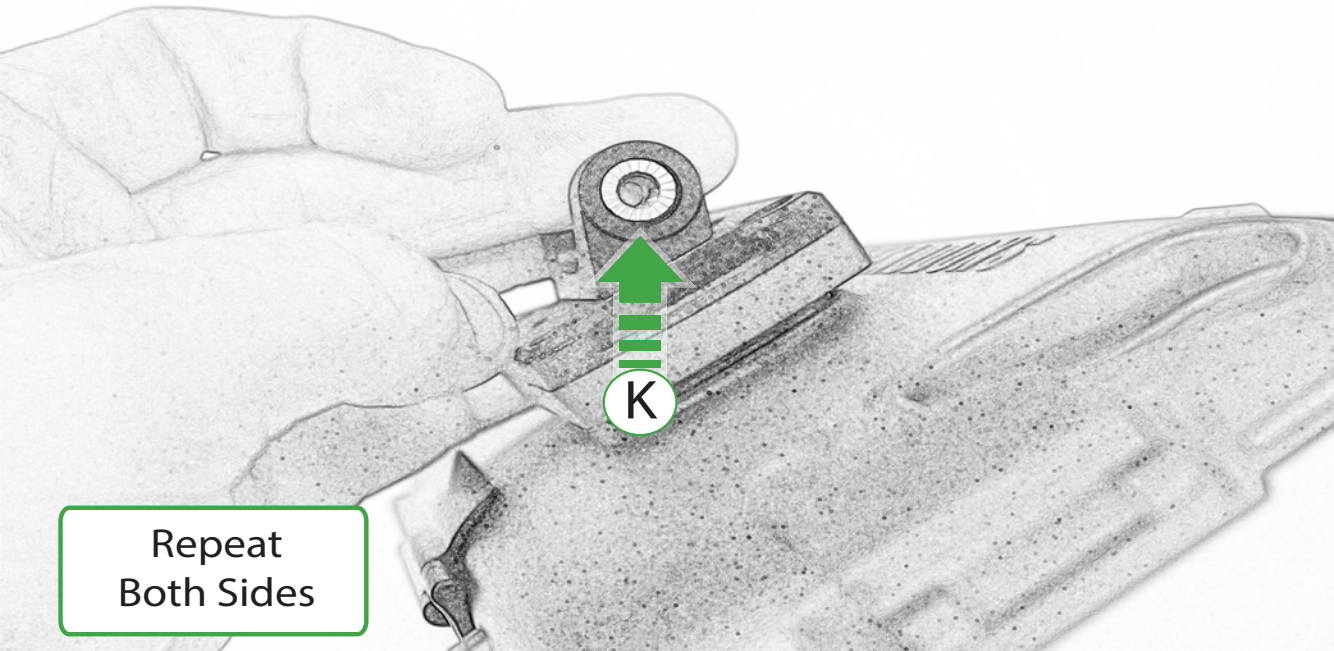

Repeat  
Both Sides

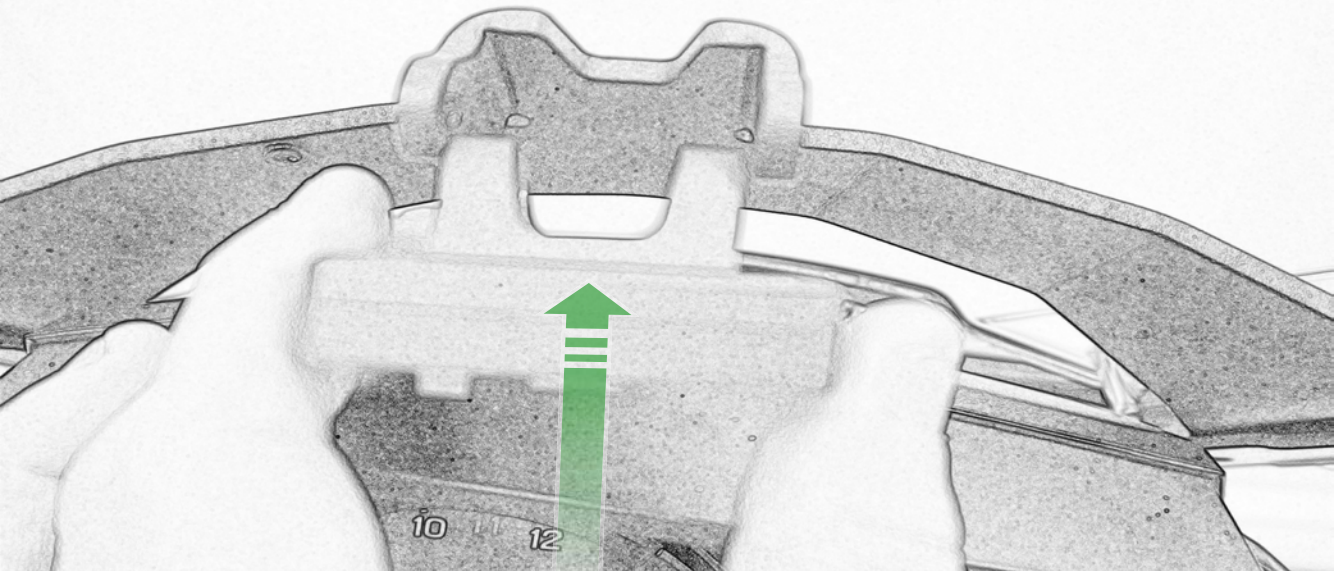

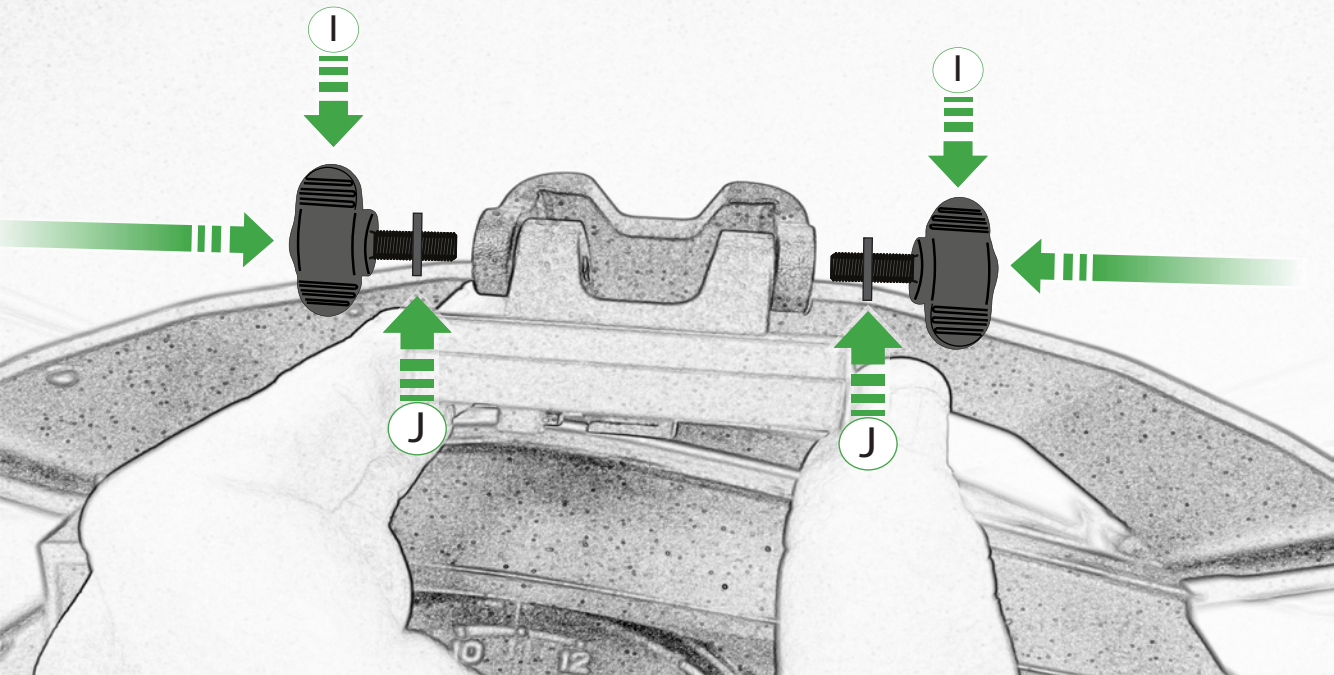

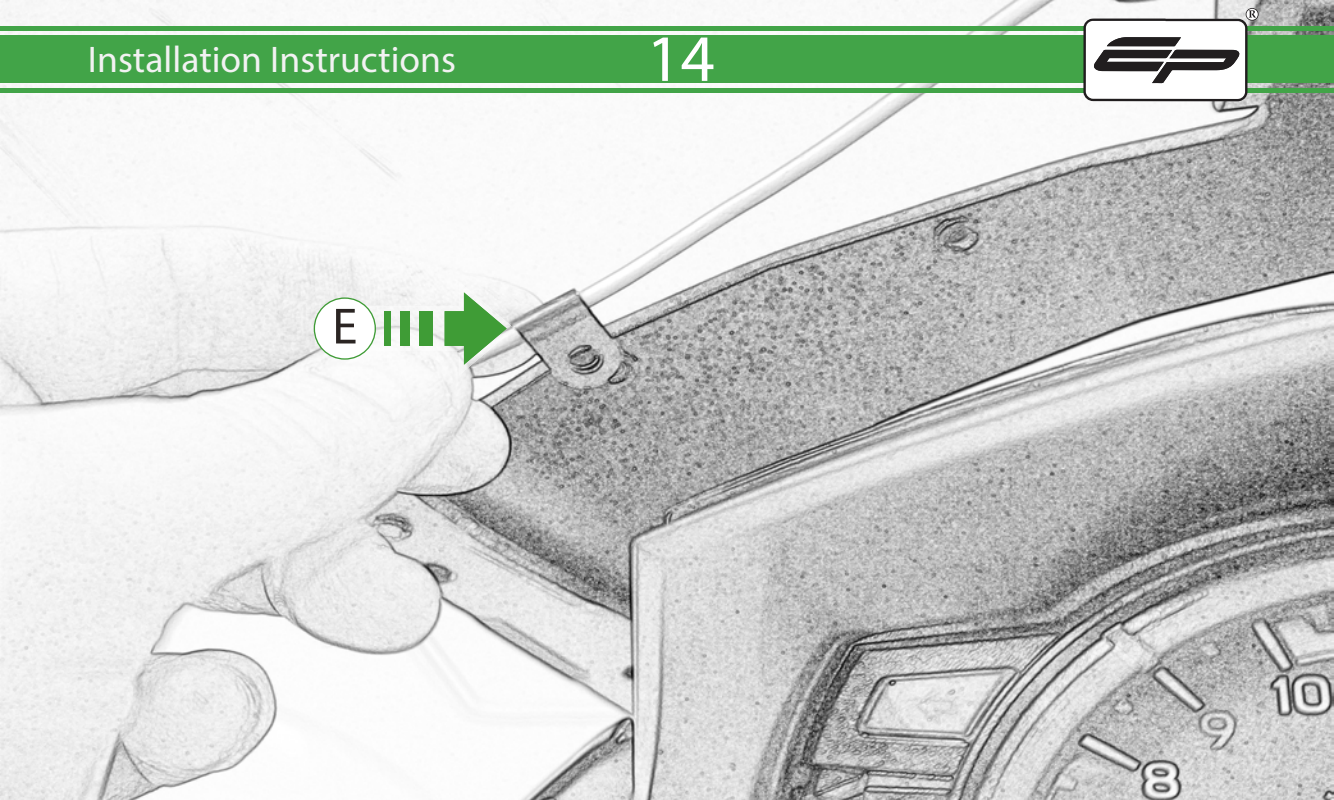



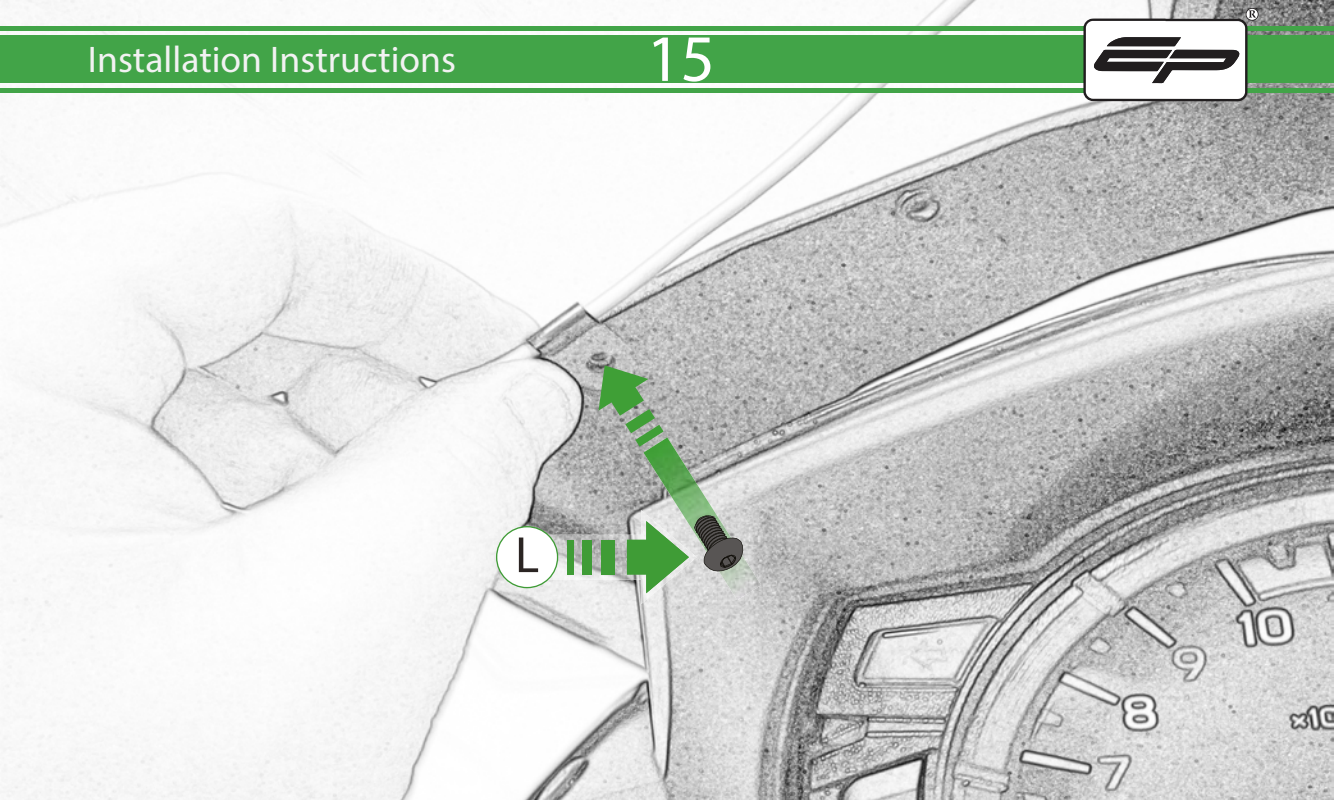

L



## ESSENTIAL CHECKS

It is recommended that periodic inspections are made to ensure that all bolts are tightened to the specified torque settings.

Should the bike be involved in an accident a thorough inspection should be made and any components that have taken an impact, no matter how small, be replaced



**EVOTECH**®  
P E R F O R M A N C E

[www.evotech-performance.com](http://www.evotech-performance.com)