

EVOTECH®
P E R F O R M A N C E

www.evotech-performance.com

BMW F 900 R / XR Tail Tidy

Installation Instructions



Kit Contents PRN015165

- (A) 1 x Light Body
- (B) 1 x Undertray
- (C) 1 x Undertray Plate
- (D) 1 x Numberplate Bracket
- (E) 1 x Inner Support Bracket
- (F) 2 x Indicator Spacer
- (G) 2 x M4 x 10 Button Head Bolts
- (H) 2 x Special Washer
- (I) 2 x M5 x 16 Button Head Bolts
- (J) 2 x Undertray Spacer A
- (K) 2 x Undertray Spacer B
- (L) 4 x M6 x 16mm Button Head Bolts

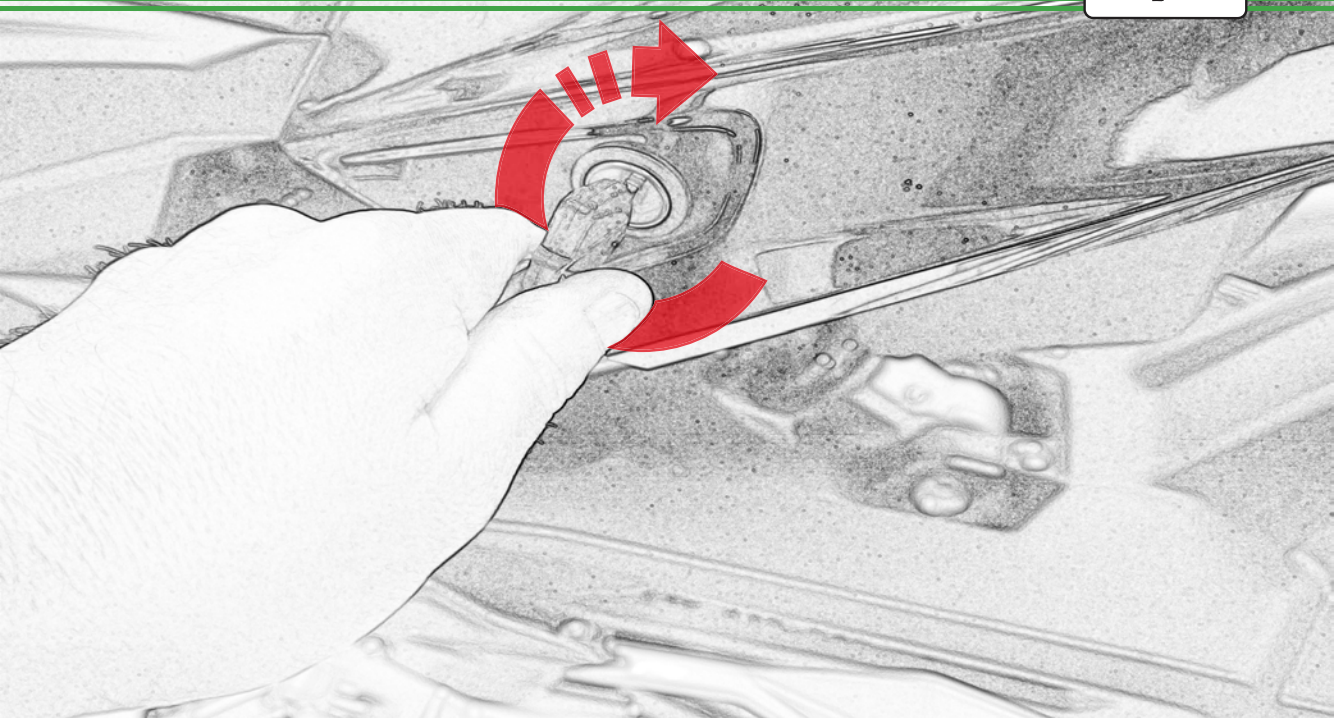

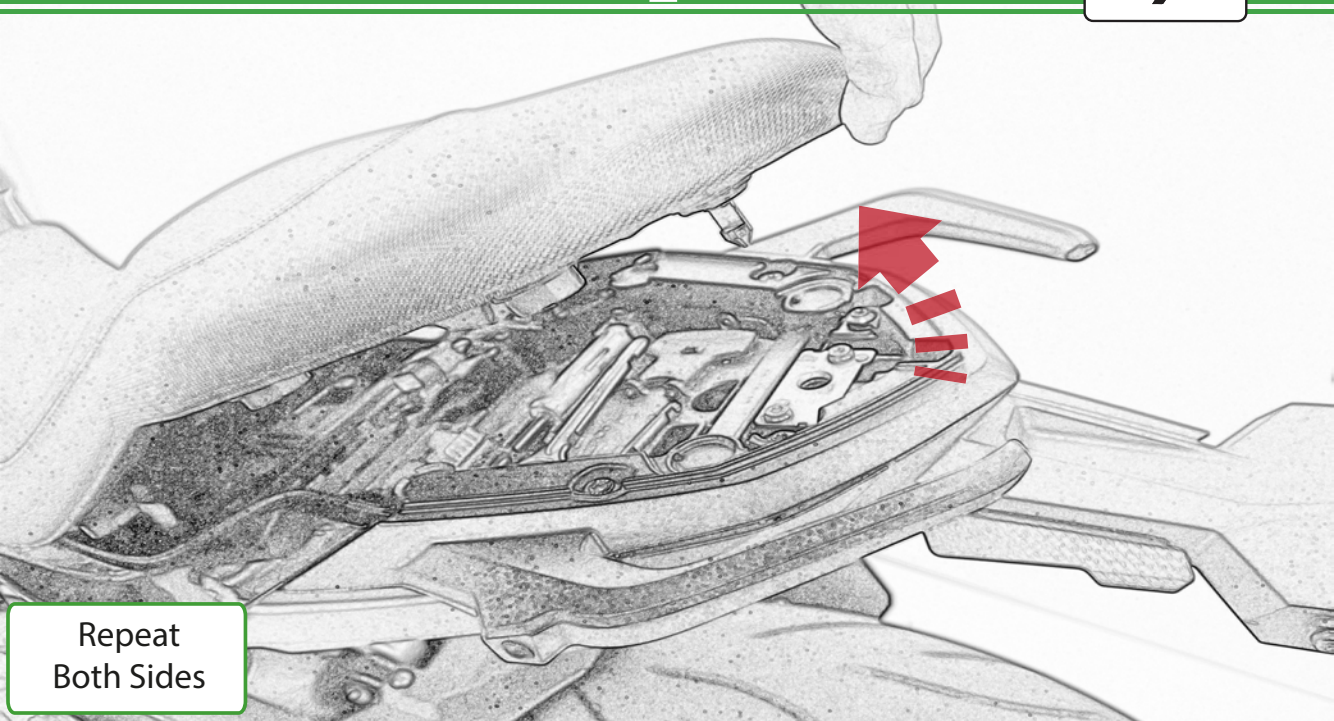

Repeat
Both Sides

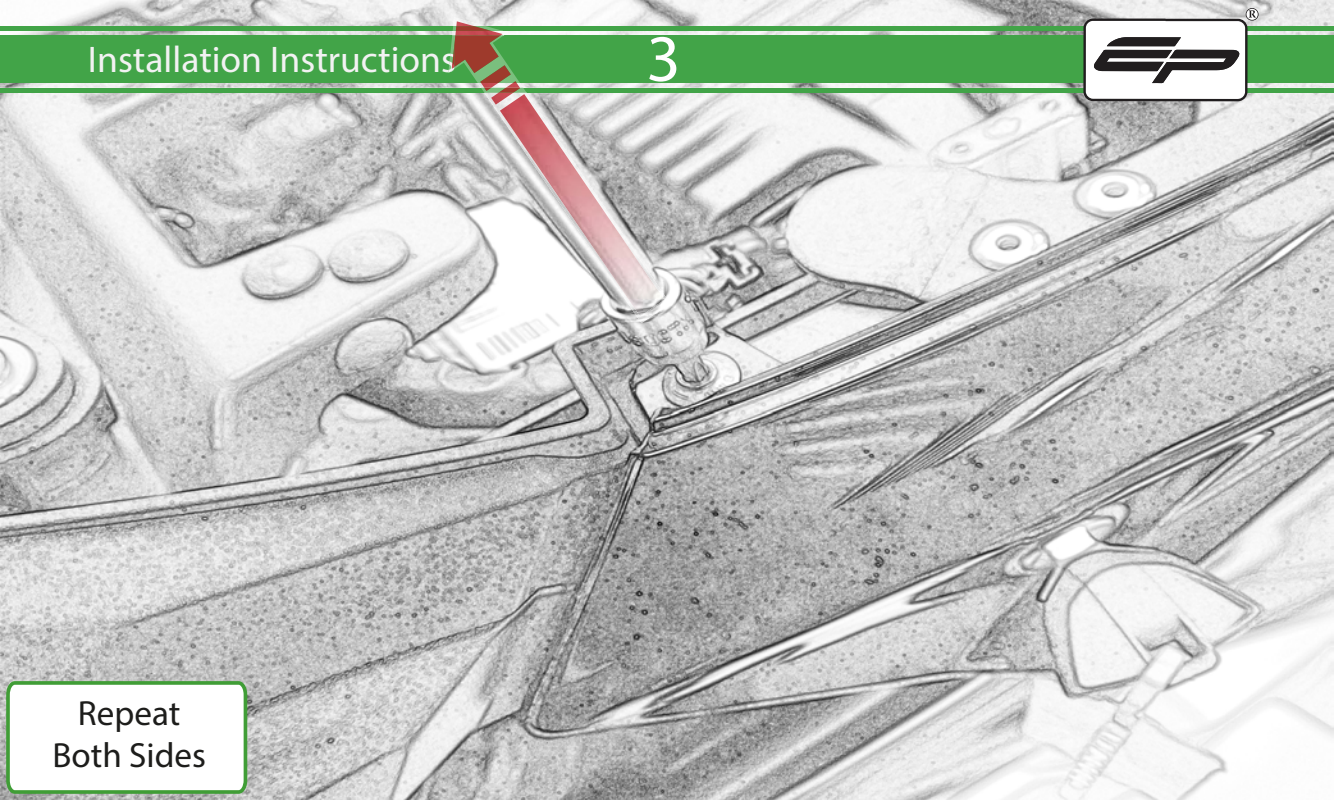

Repeat
Both Sides

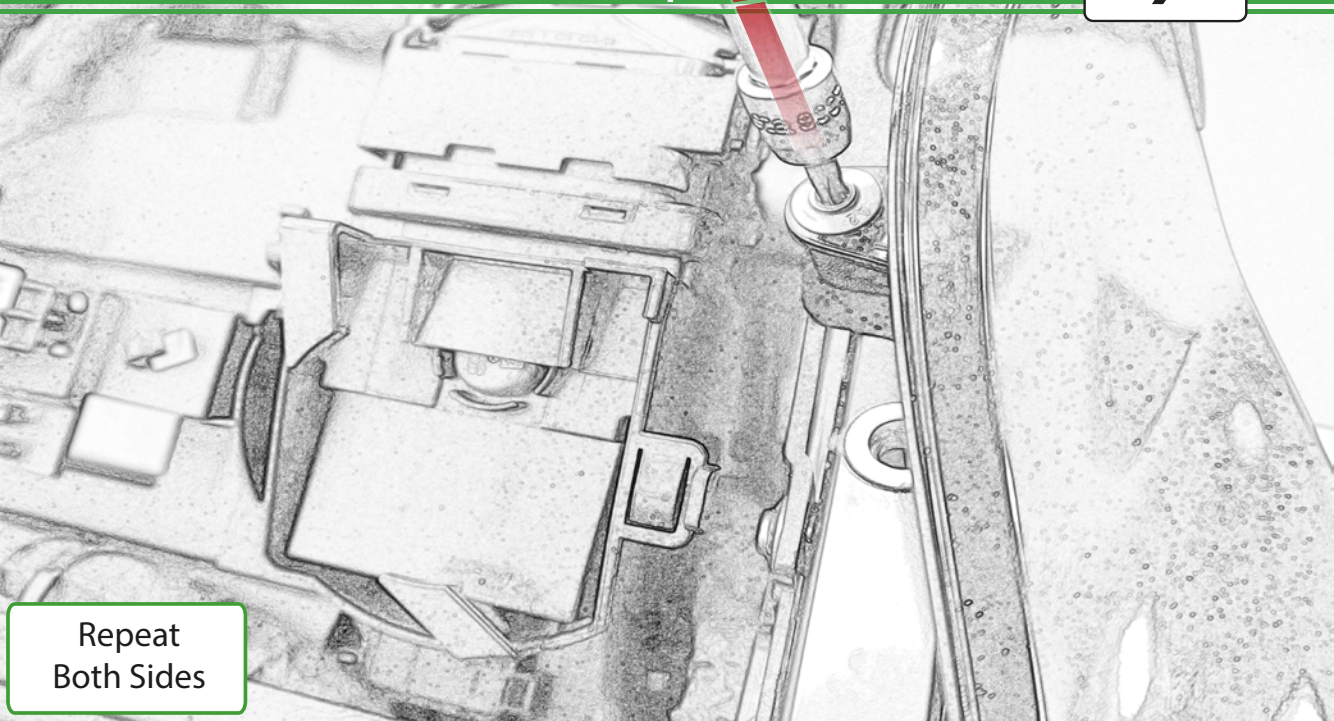

Repeat
Both Sides

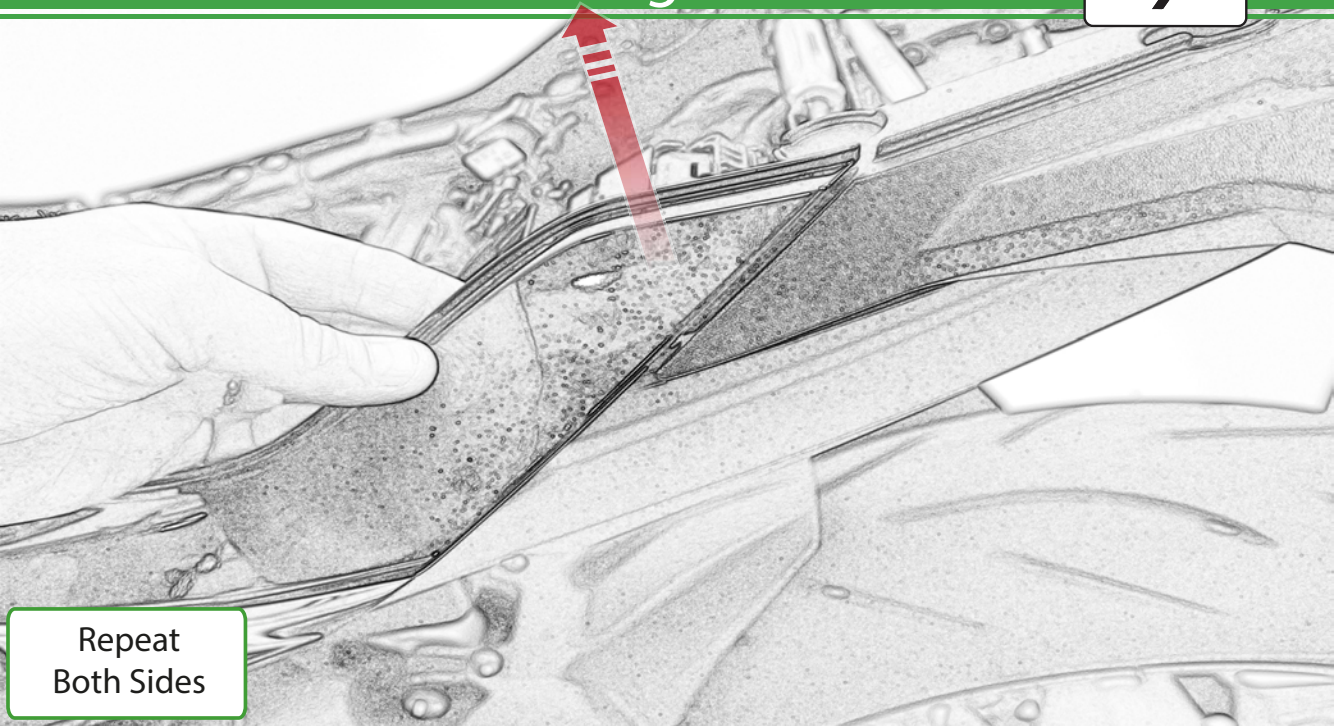

Repeat
Both Sides

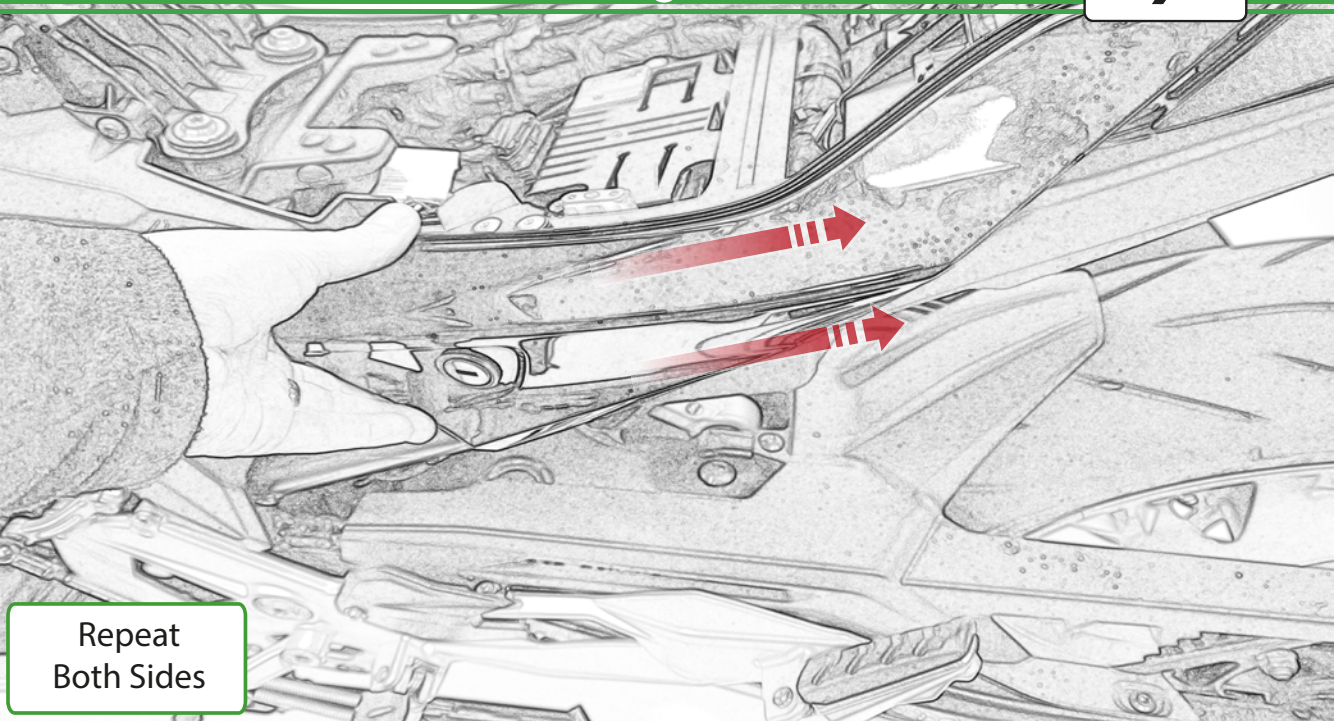

Repeat
Both Sides

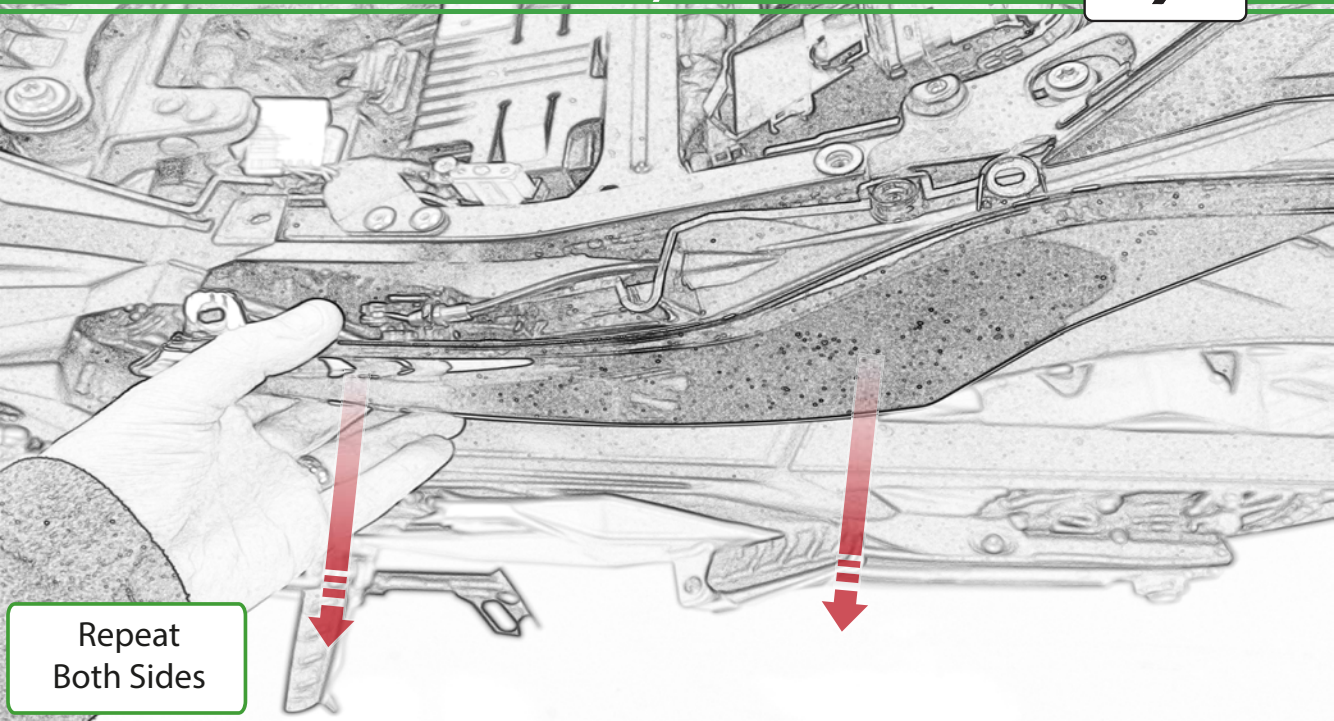

Repeat
Both Sides

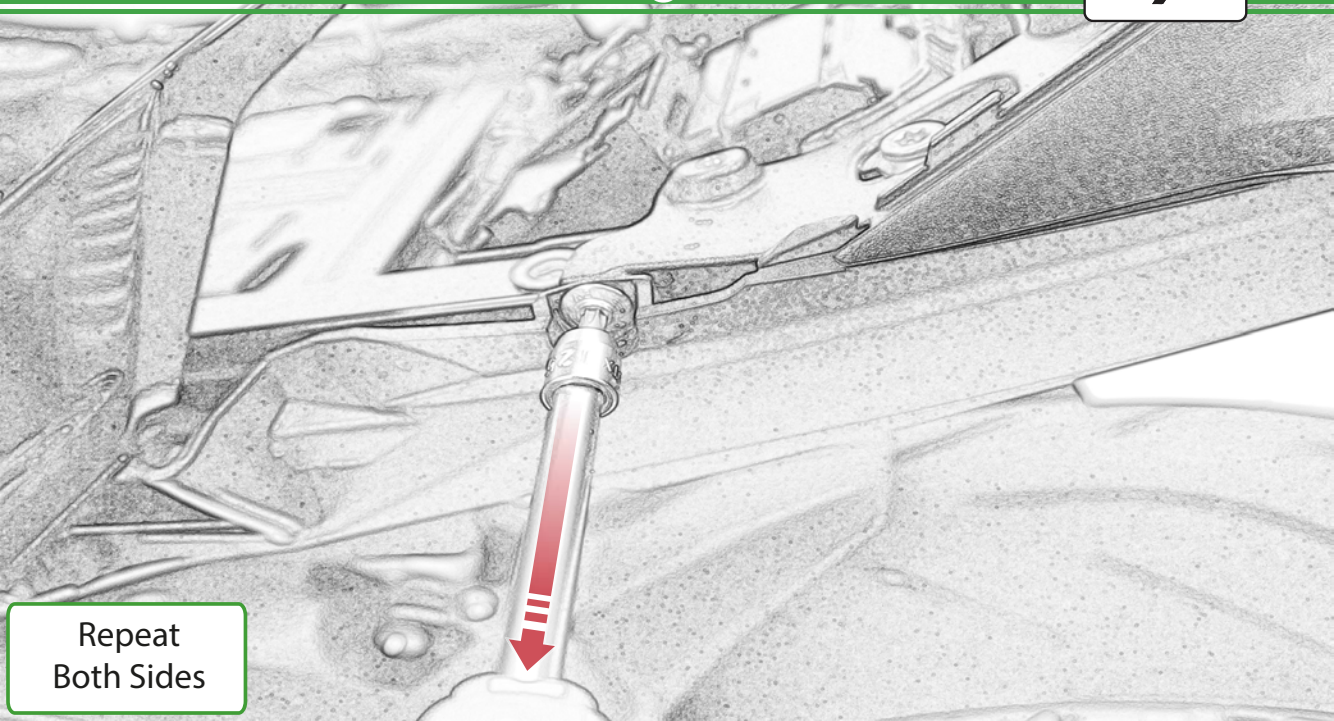

Repeat
Both Sides



Repeat
Both Sides

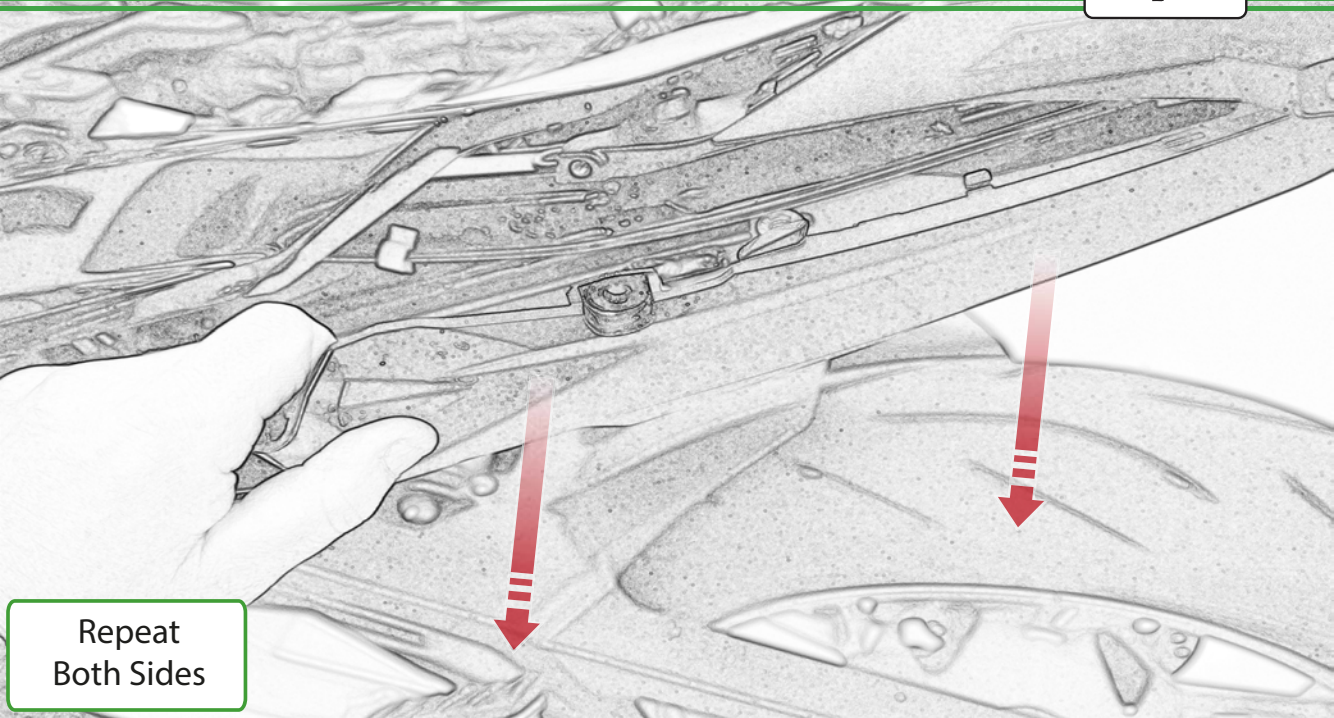

Repeat
Both Sides

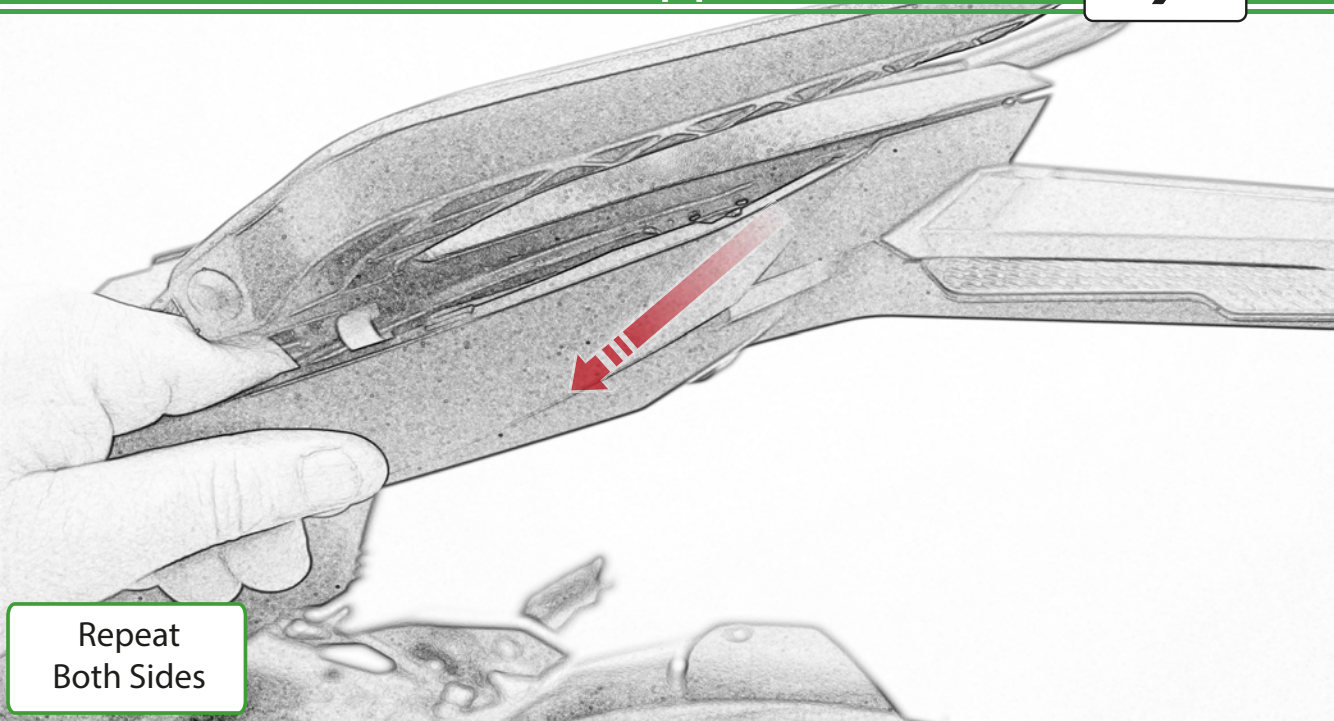

Repeat
Both Sides

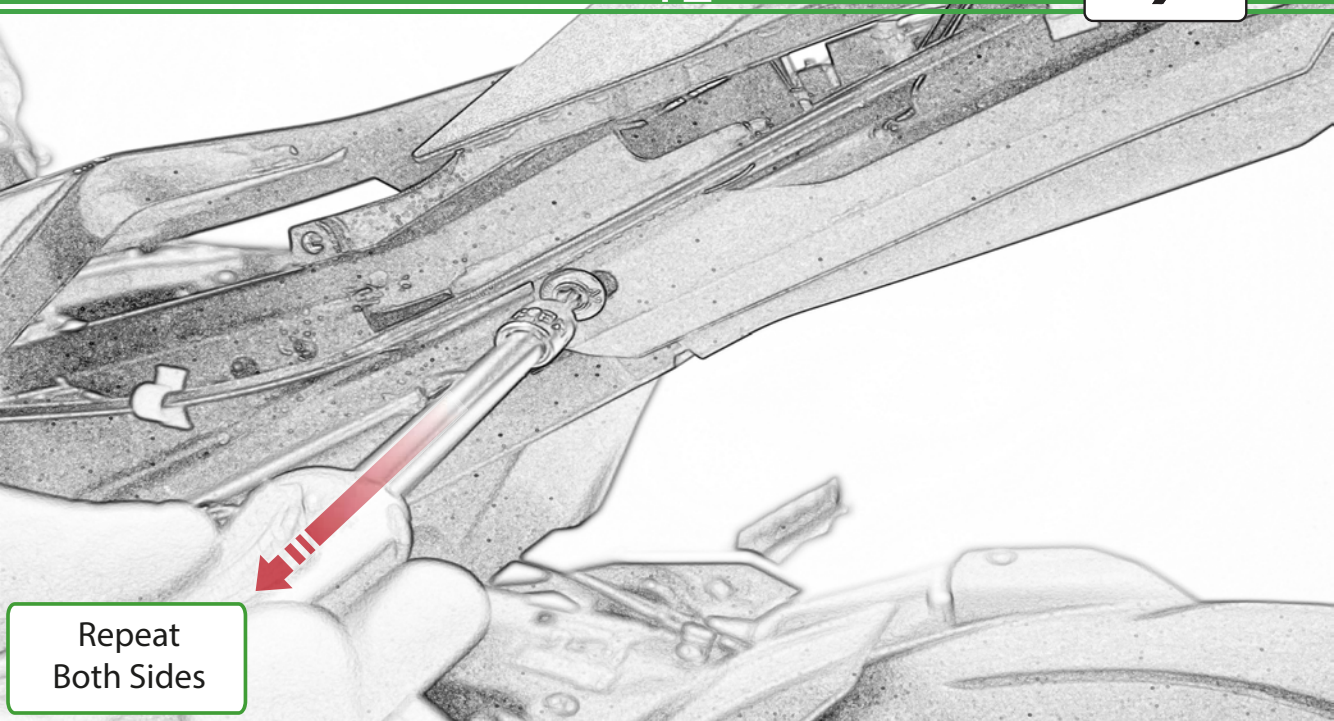

Repeat
Both Sides

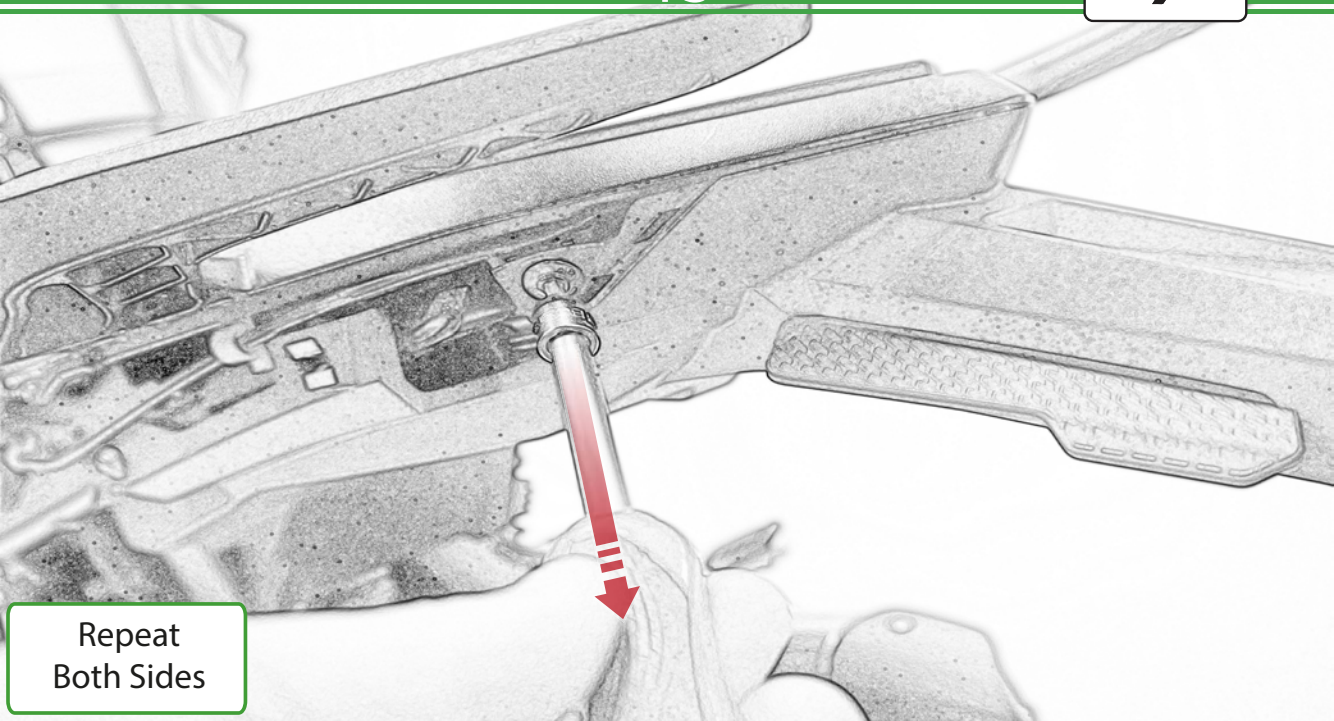

Repeat
Both Sides

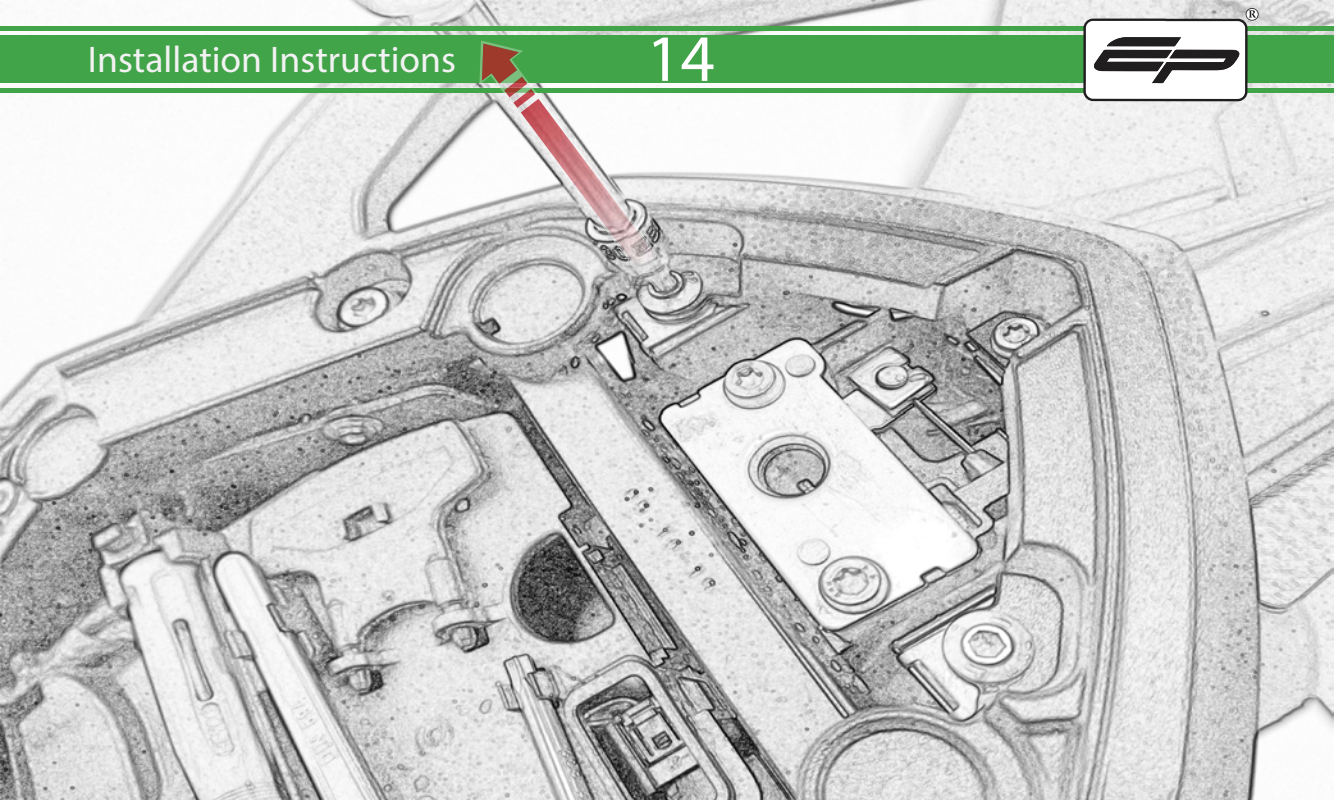

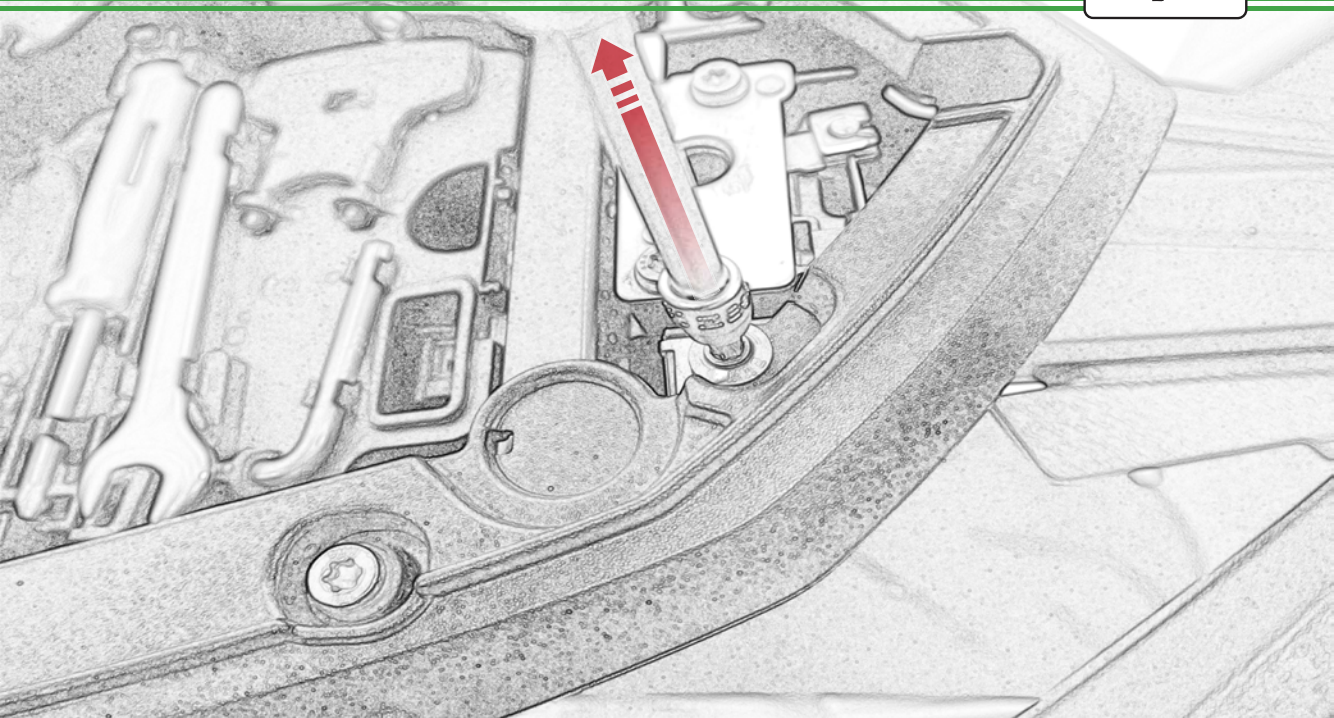

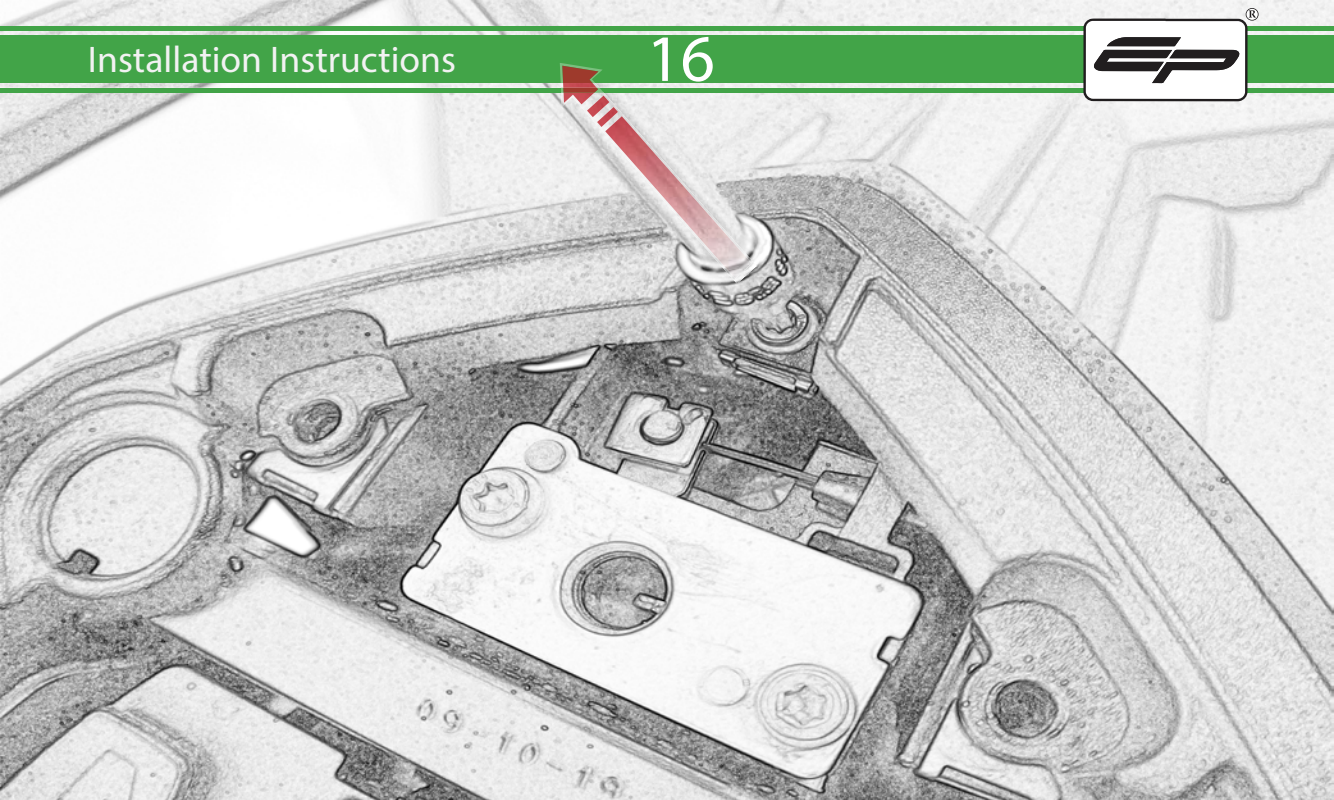

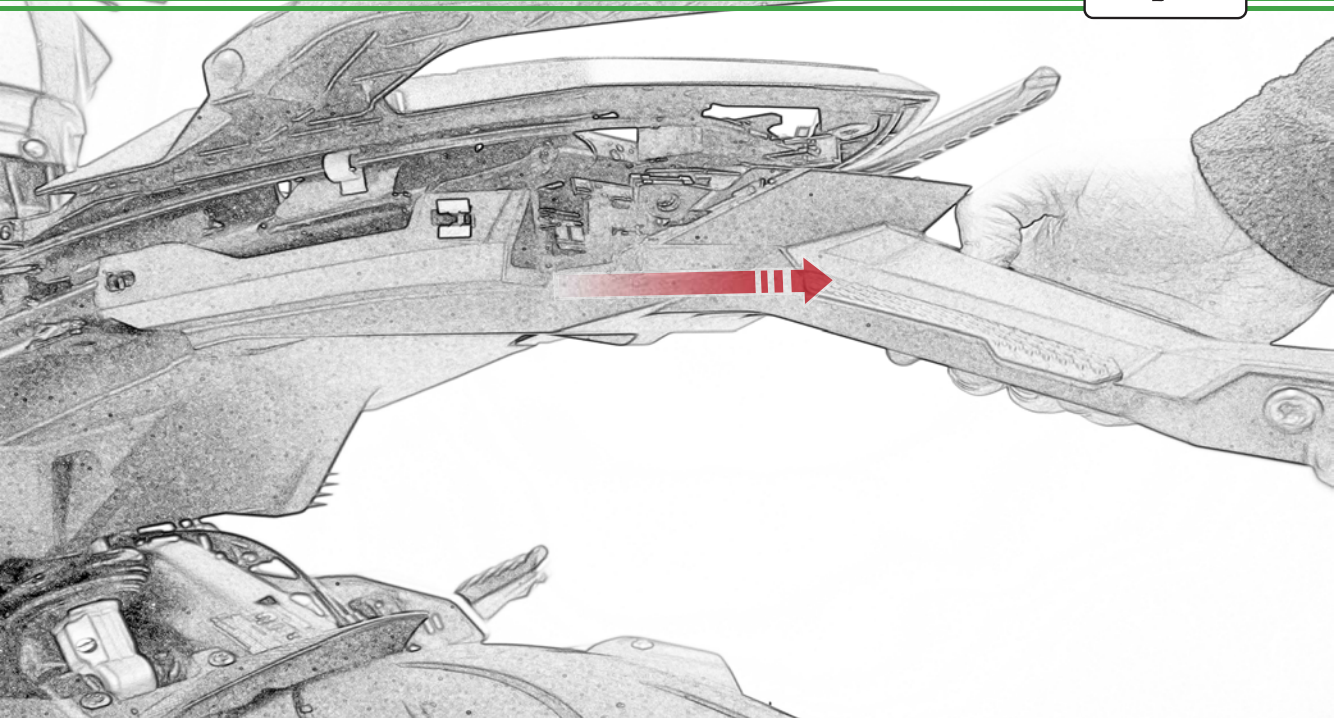

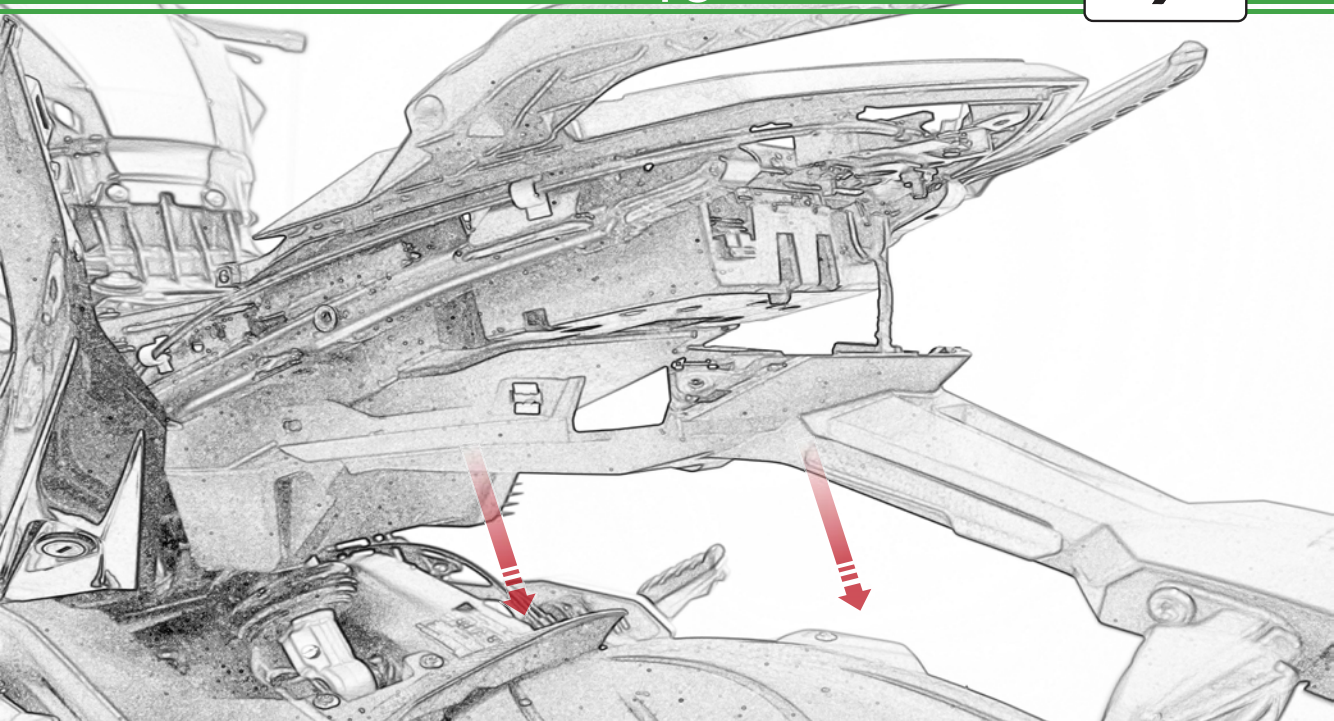

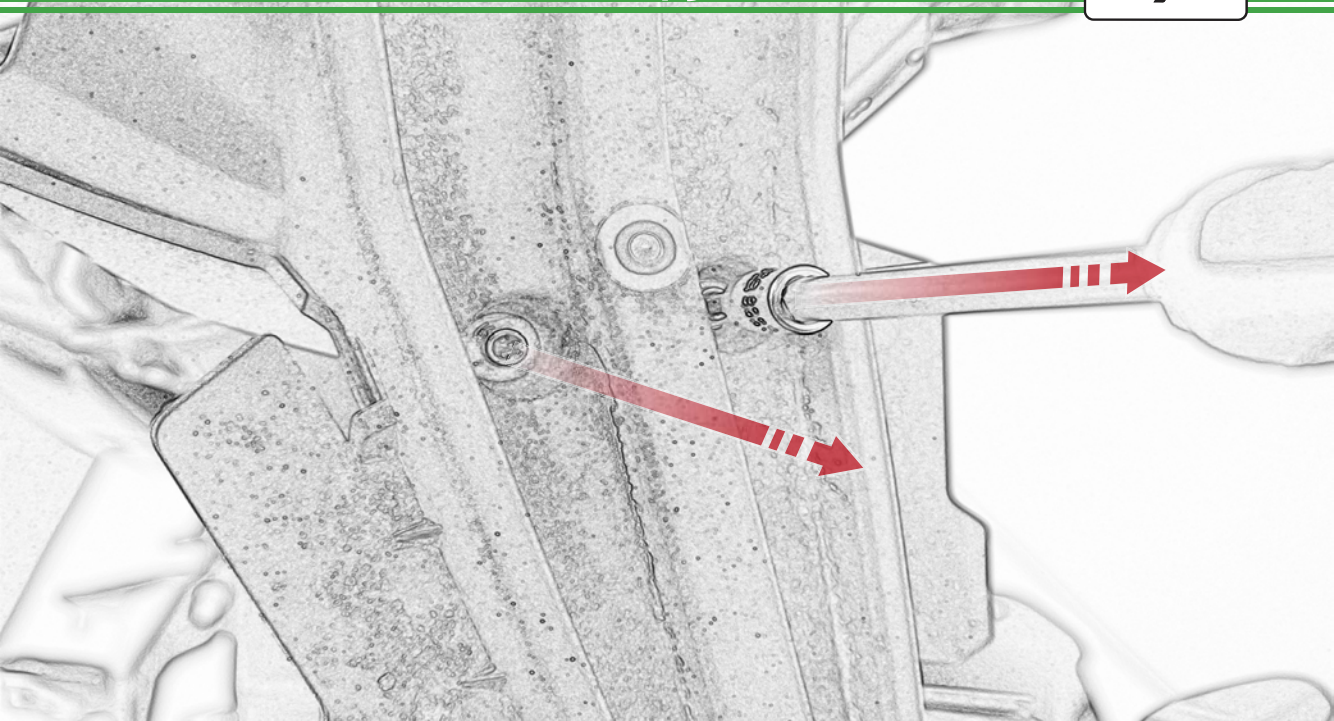

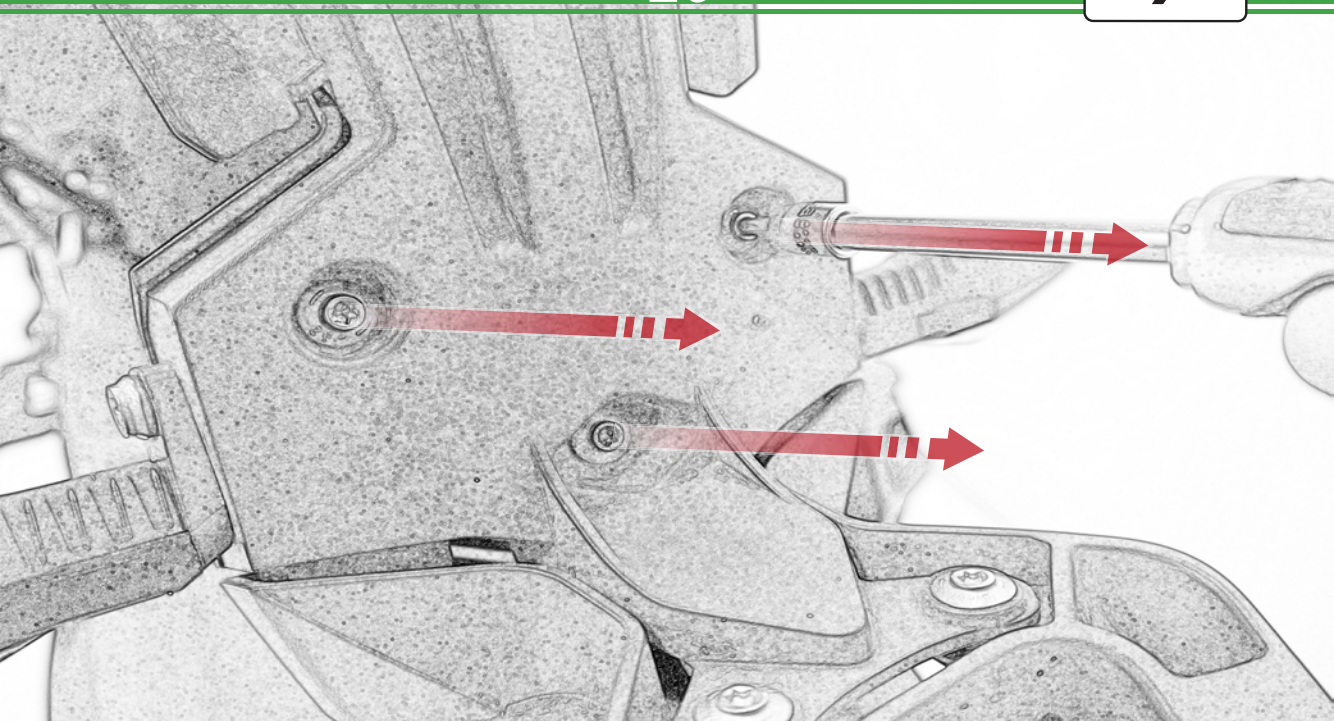

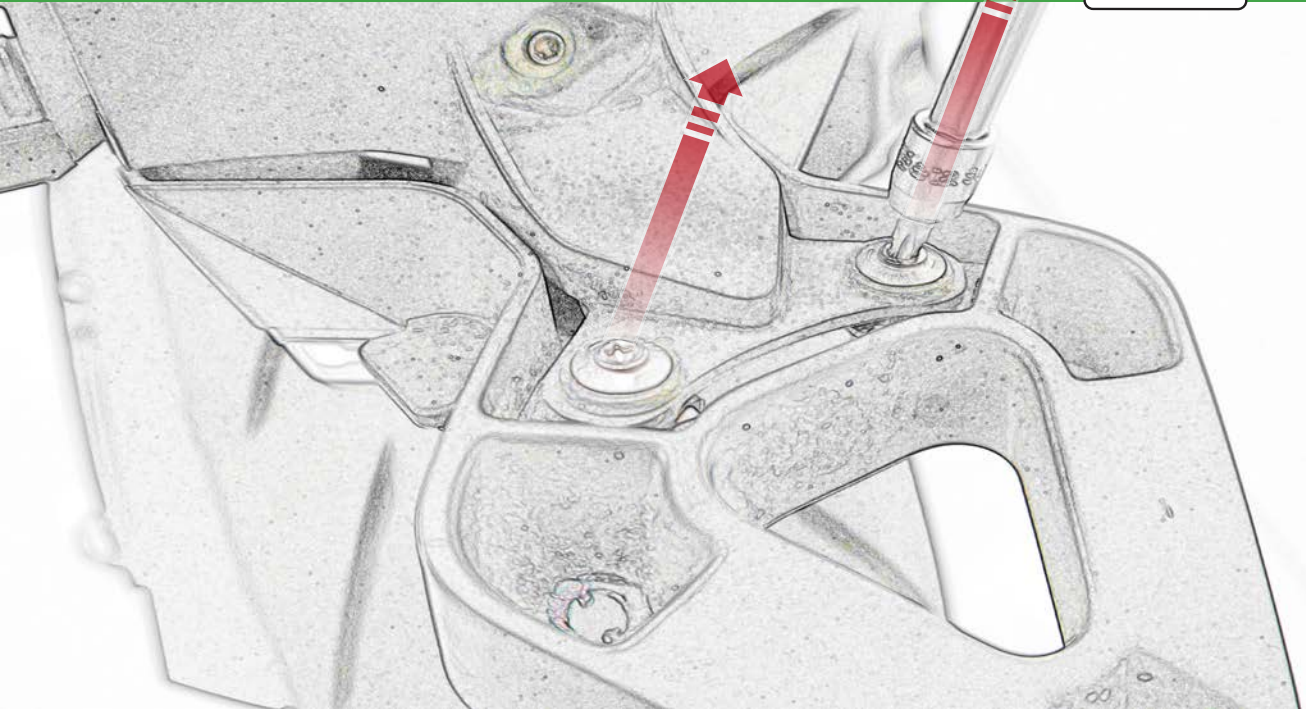

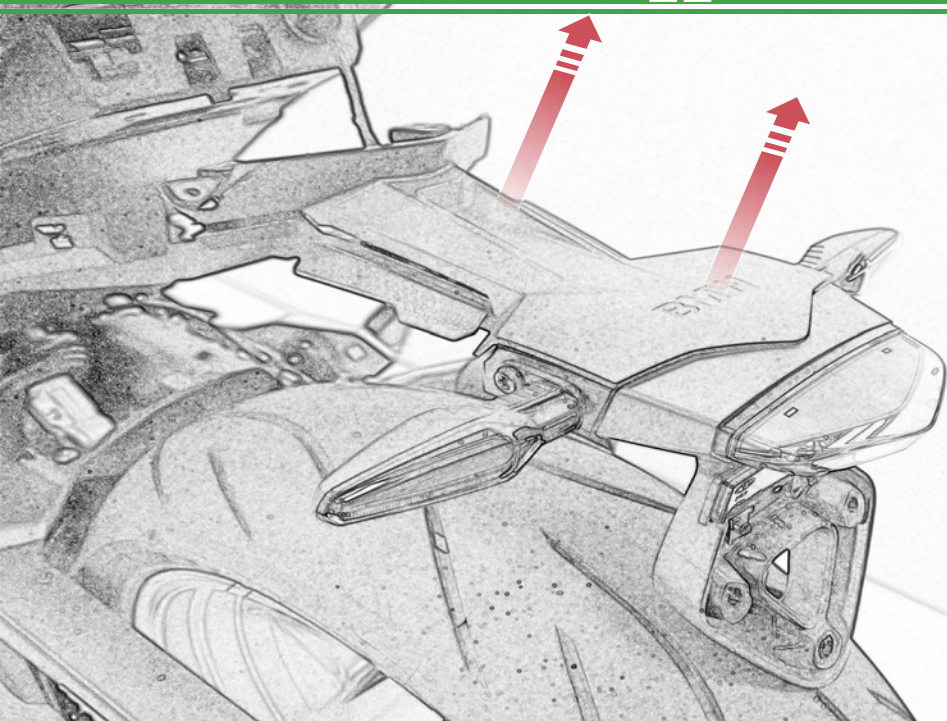

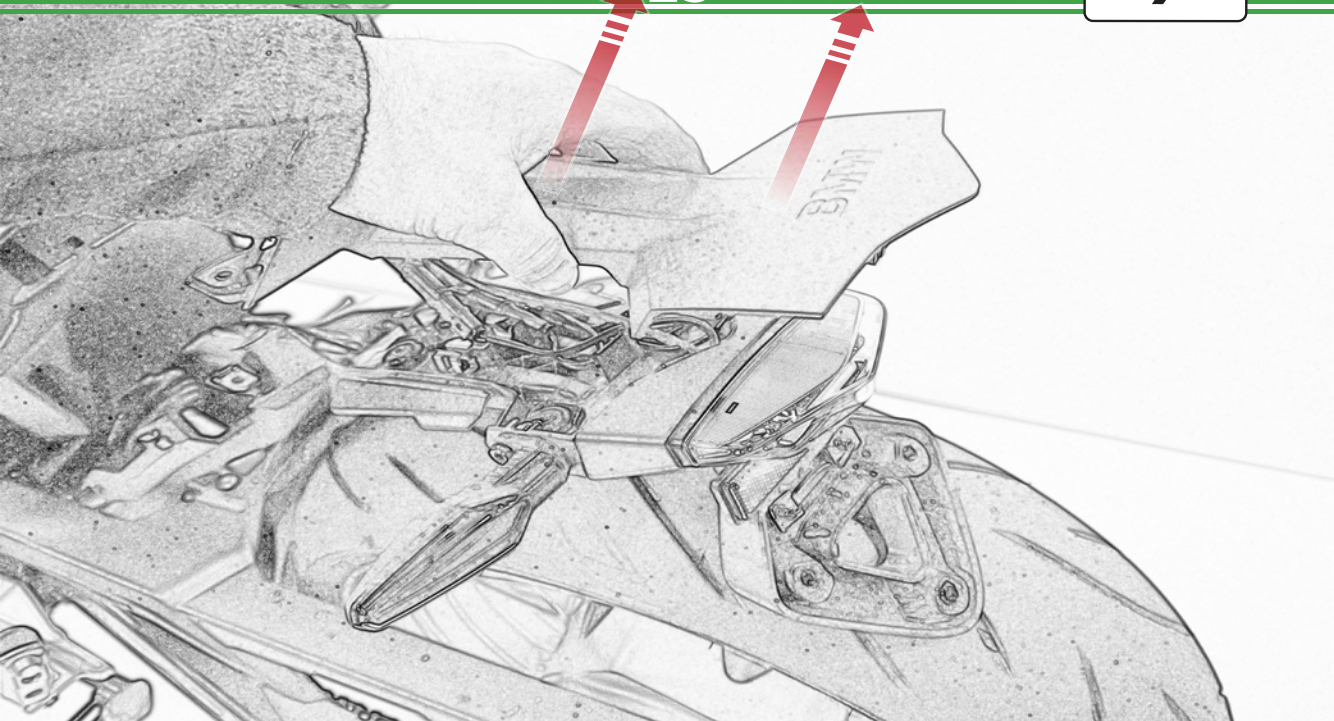

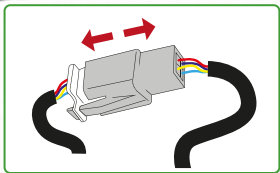
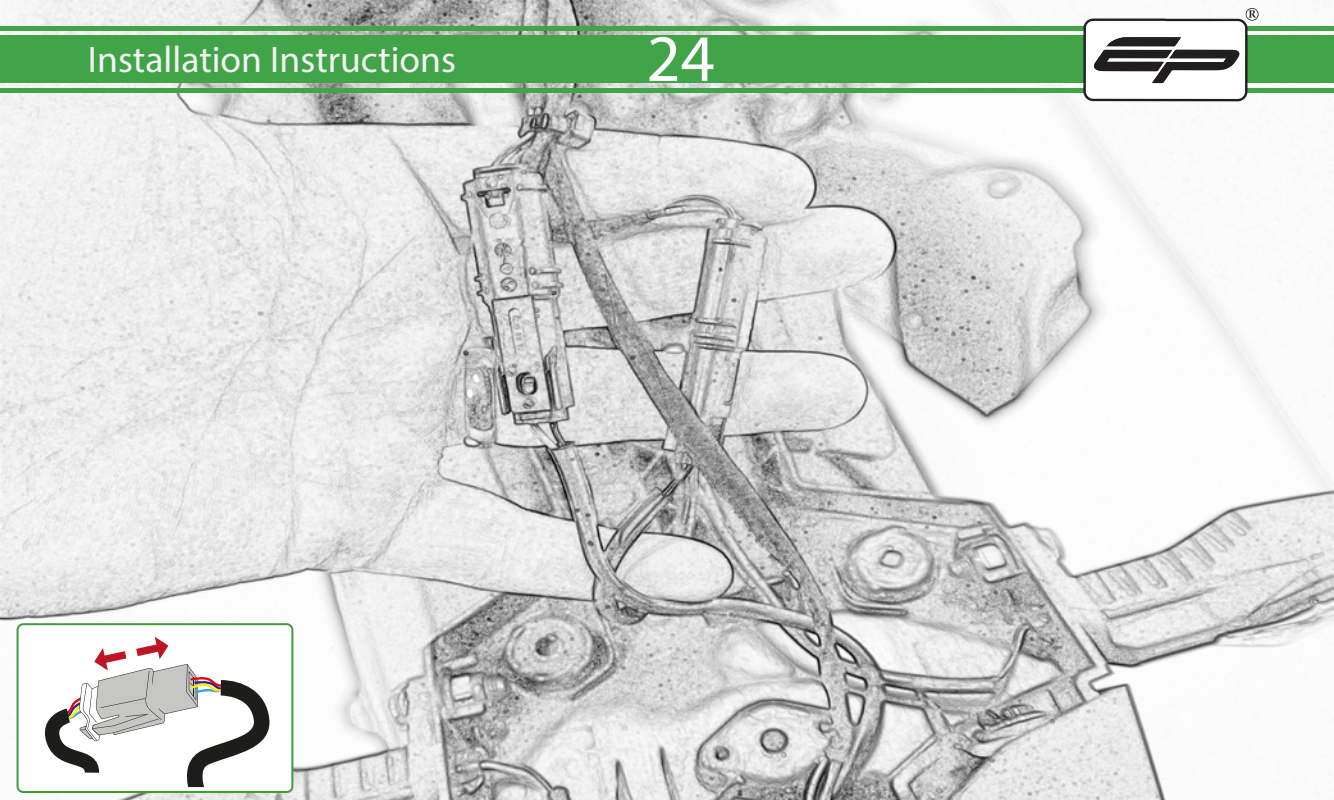

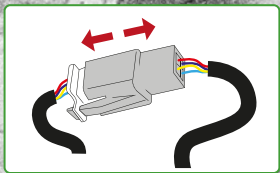
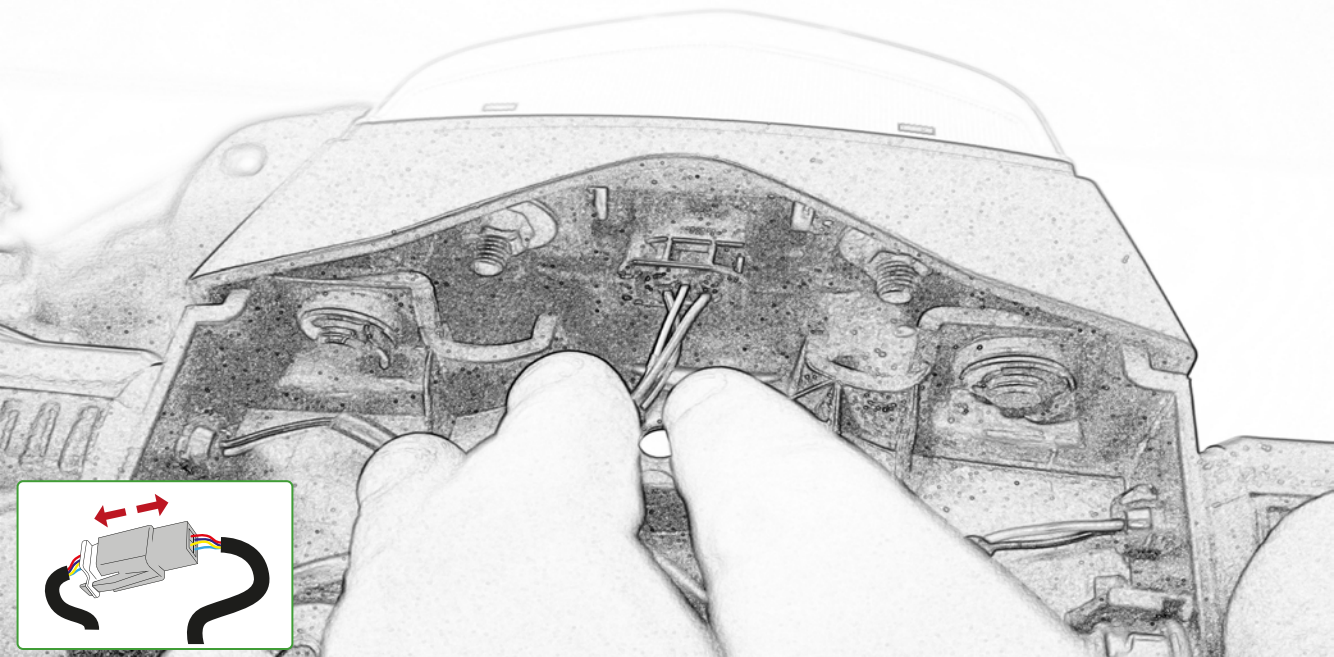

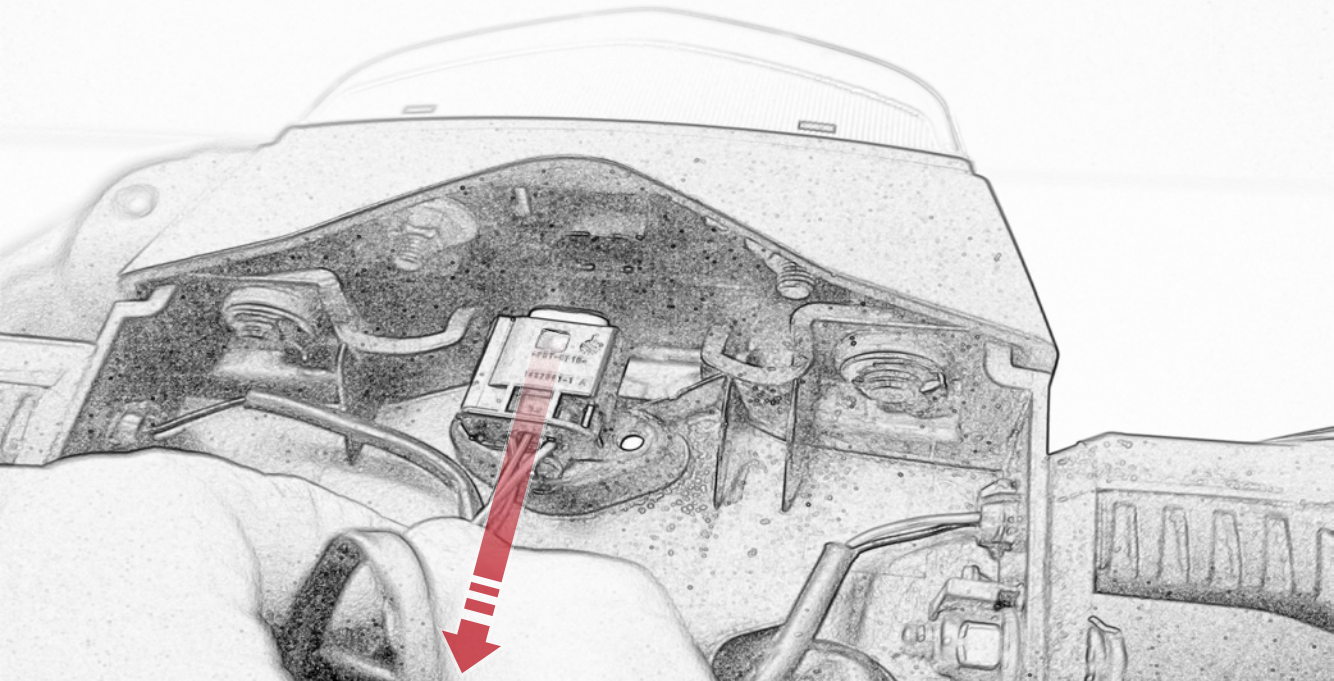

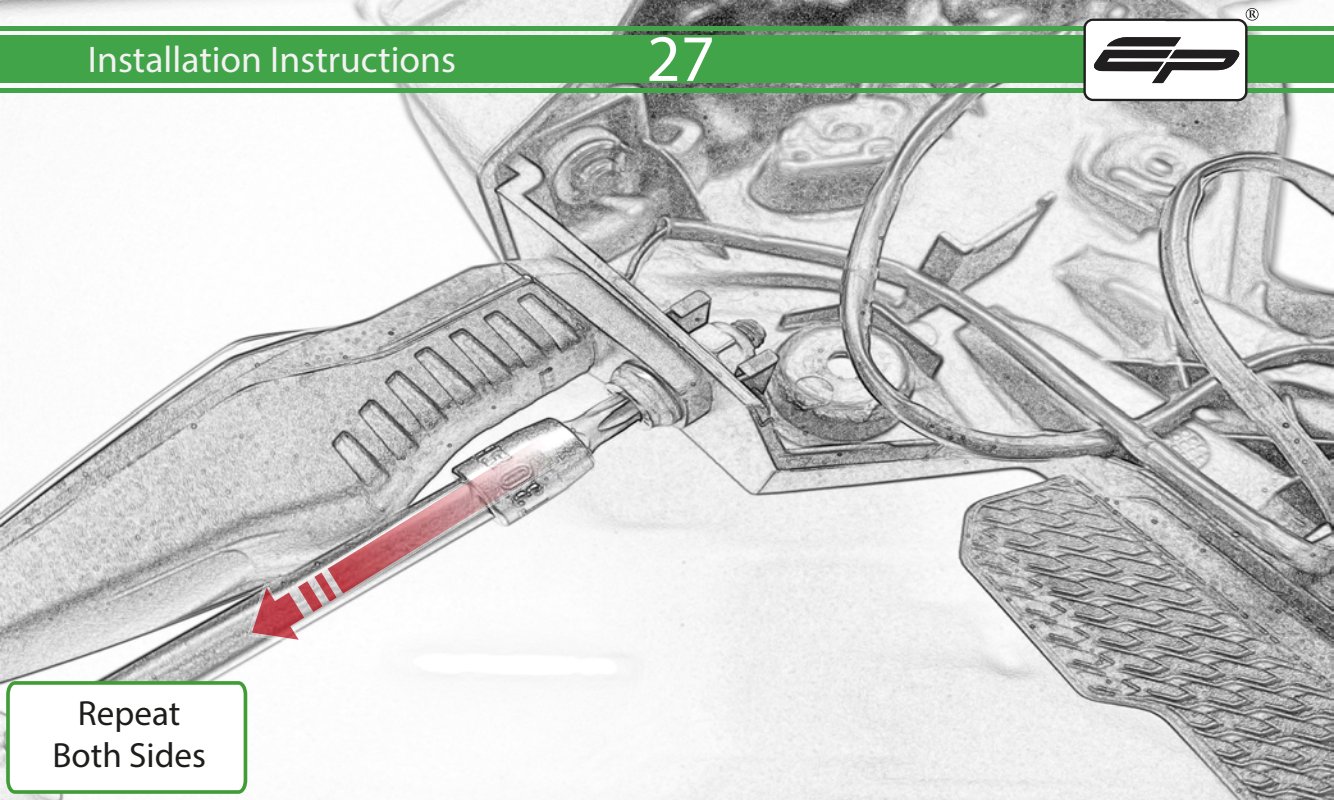

Repeat
Both Sides

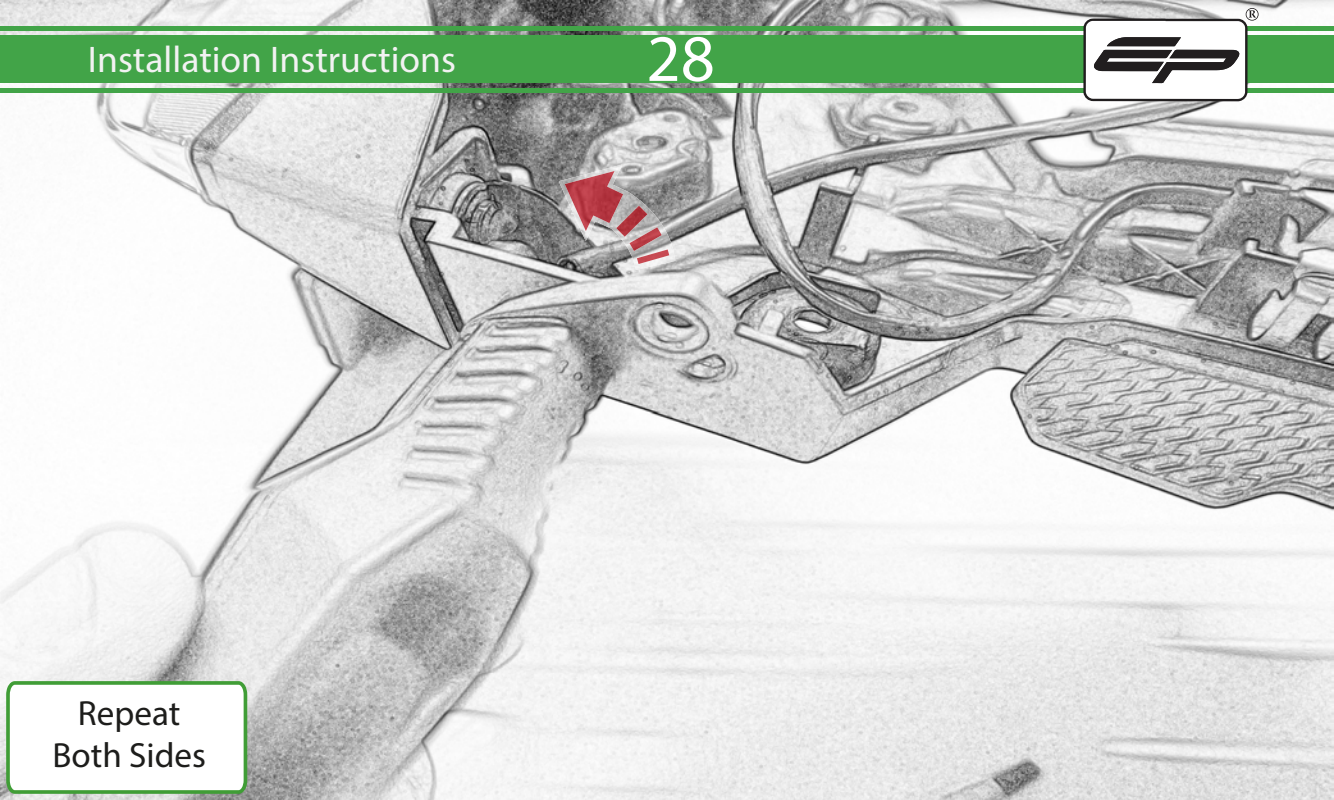

Repeat
Both Sides

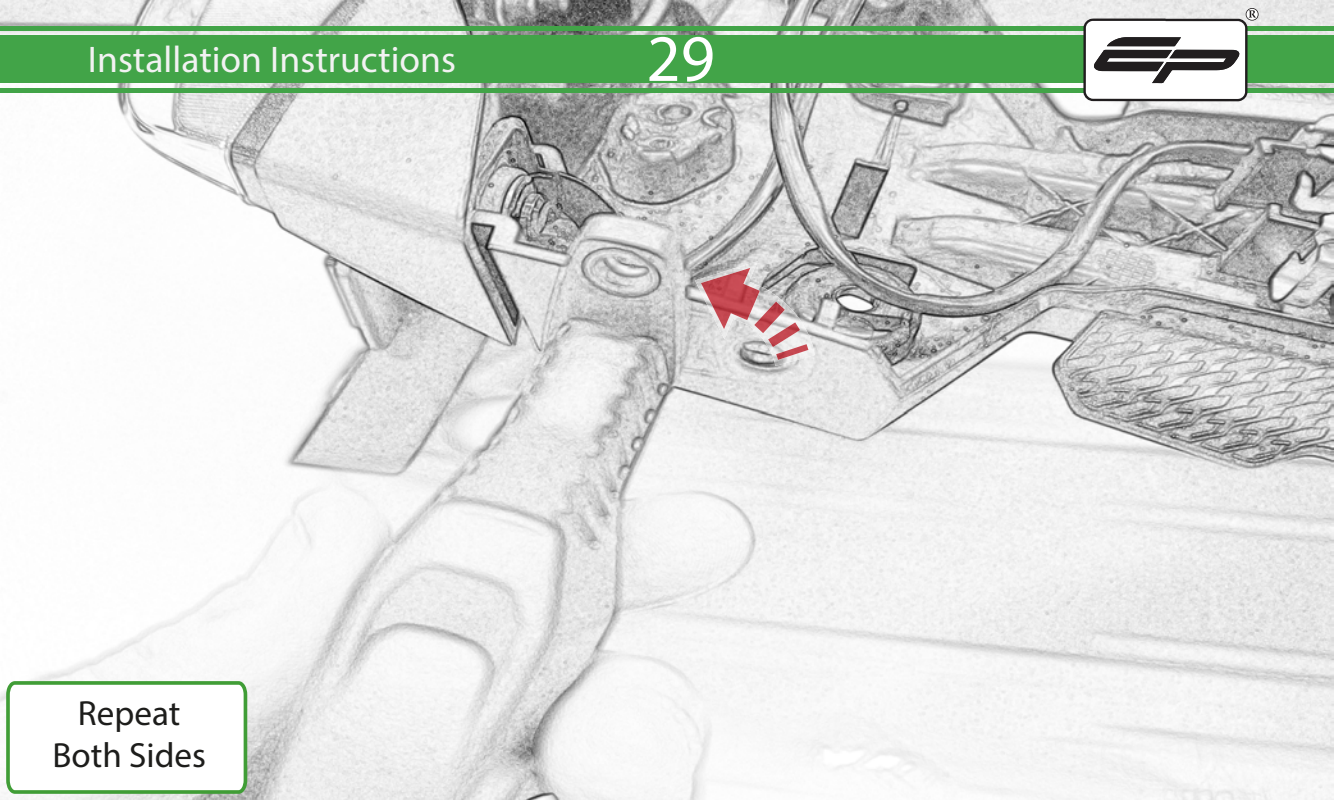

Repeat
Both Sides

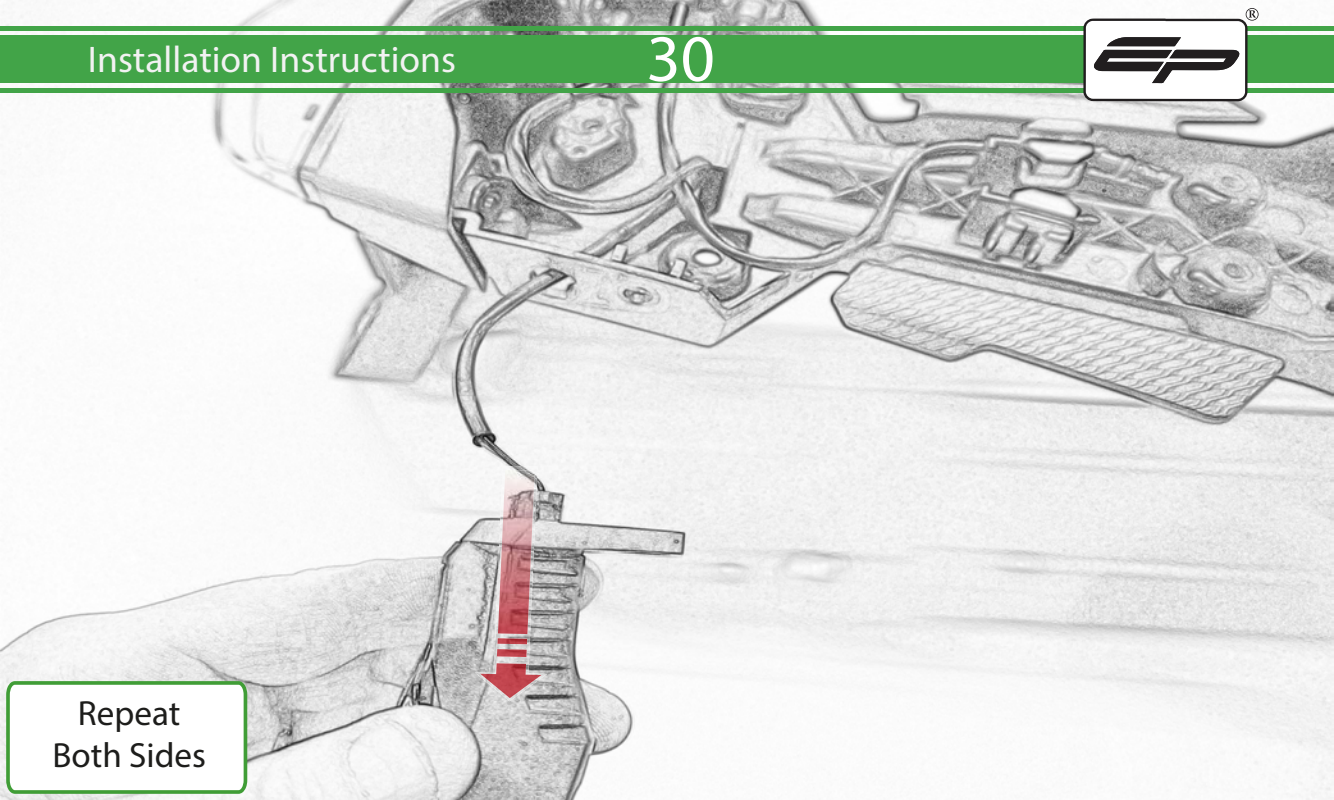

Repeat
Both Sides

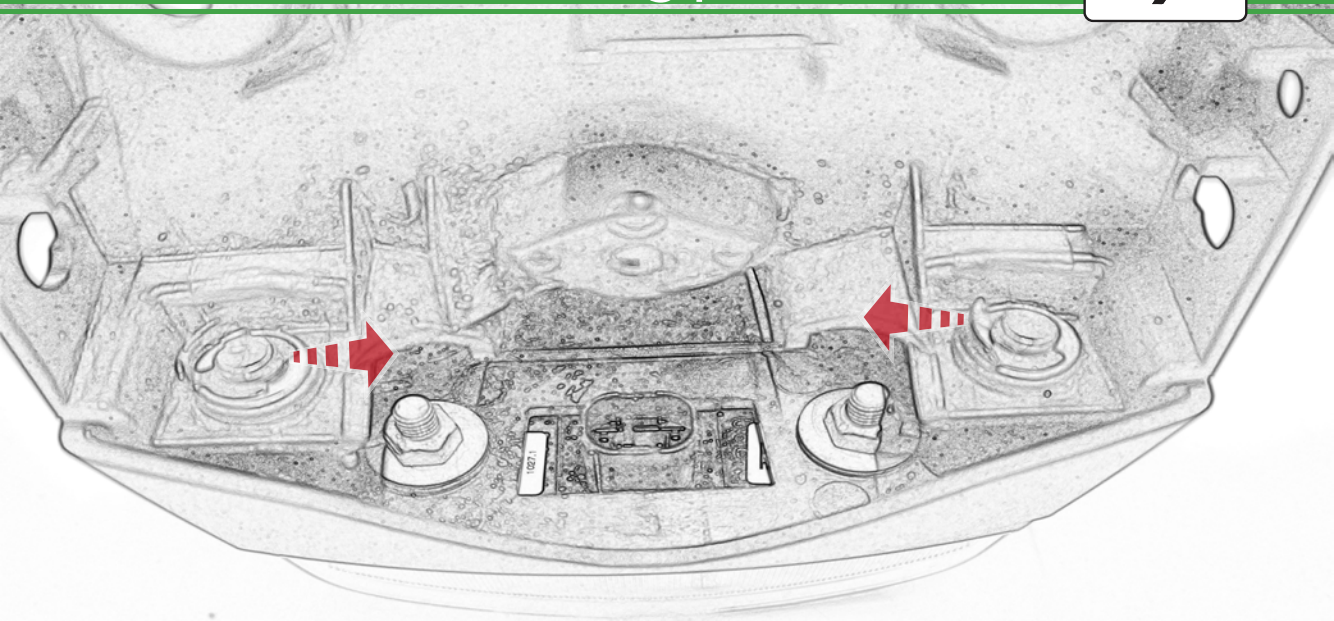

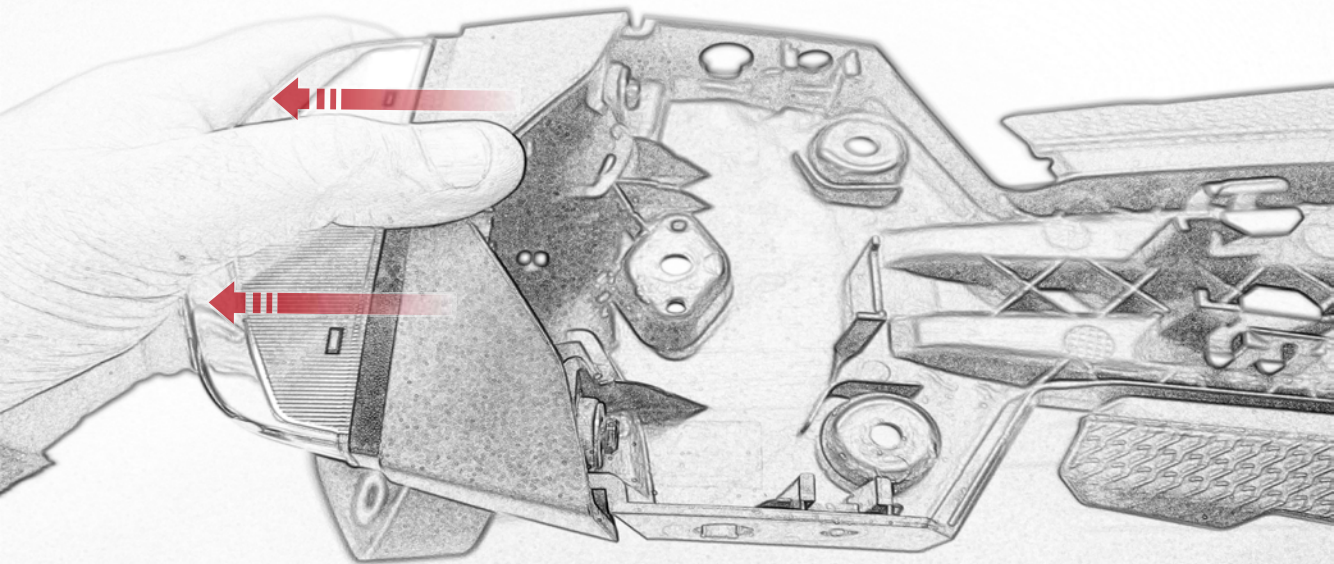

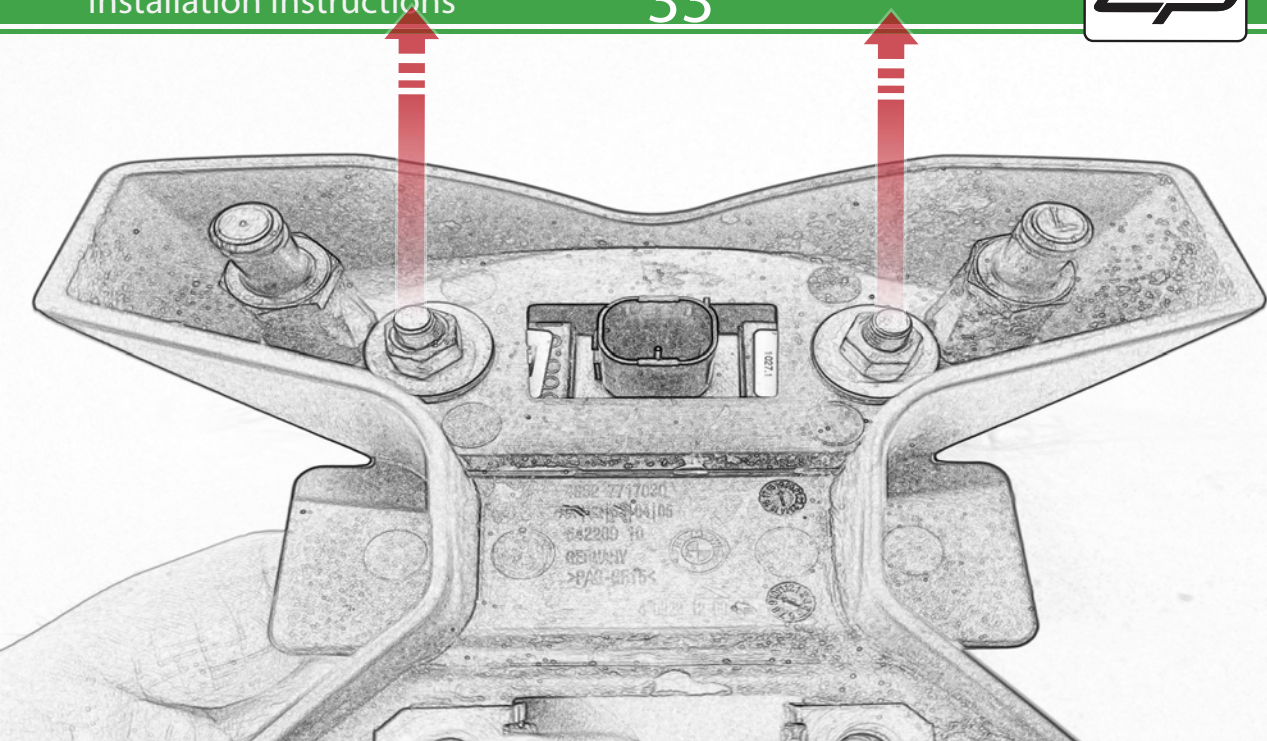

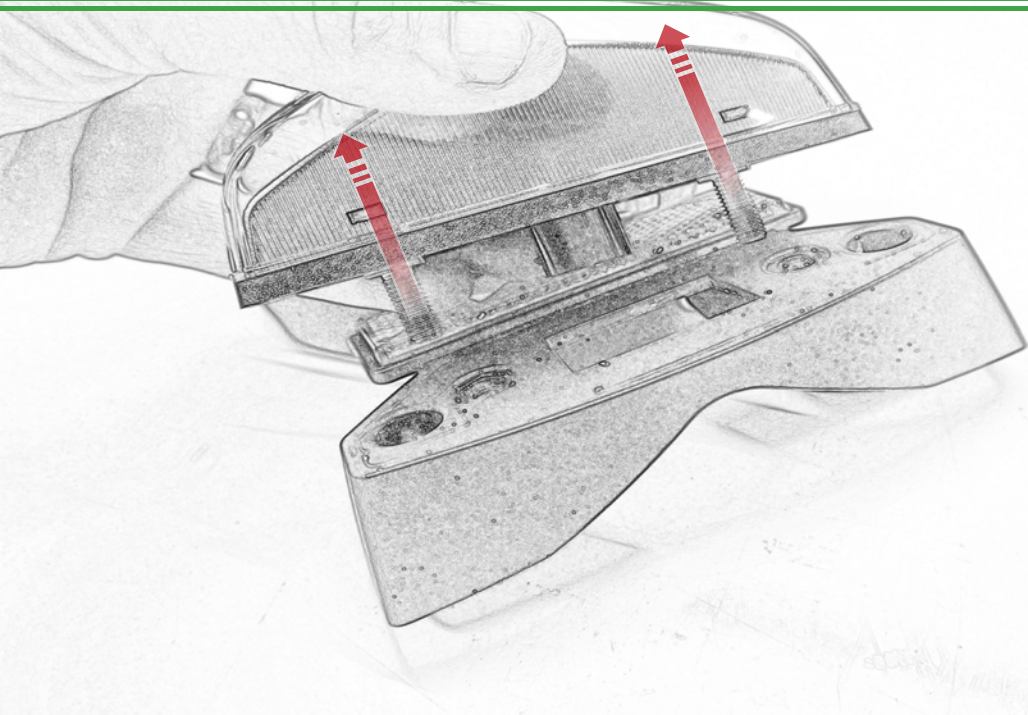

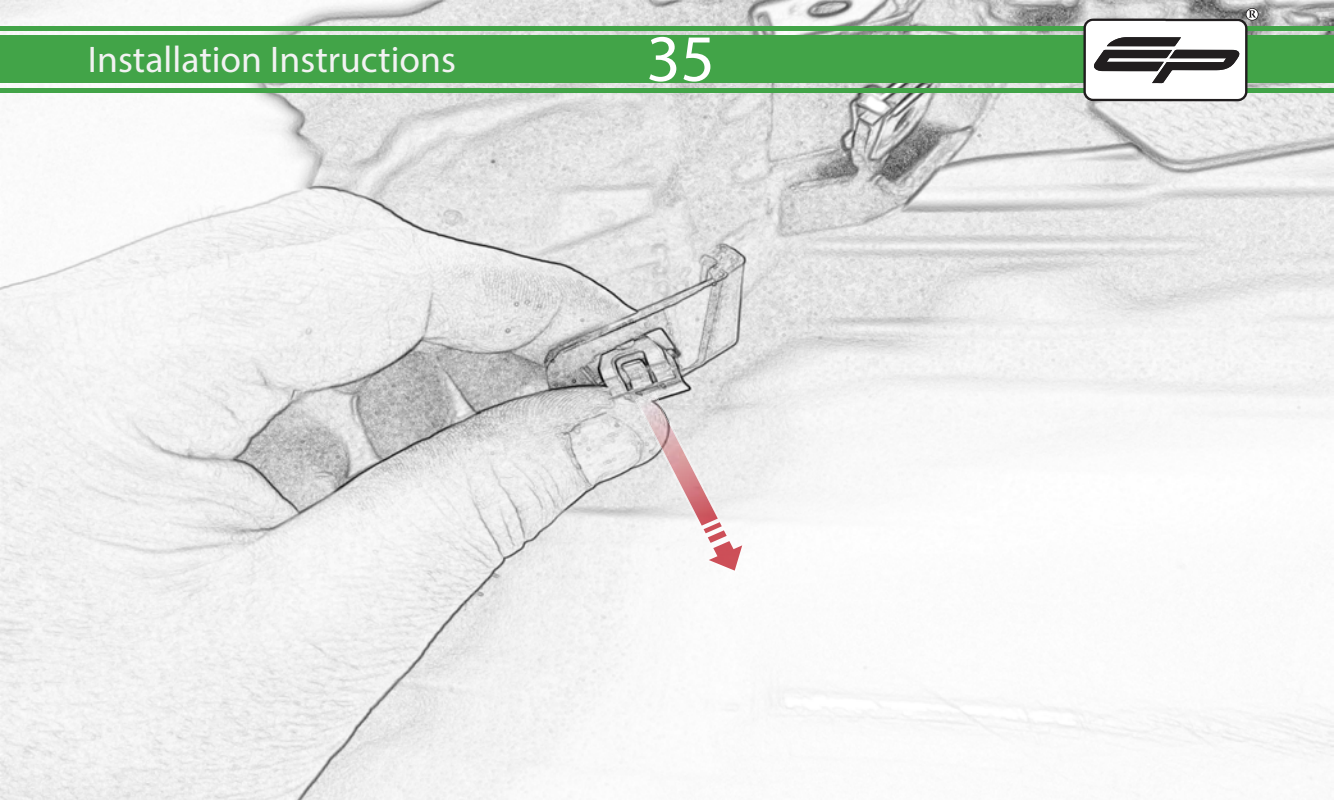

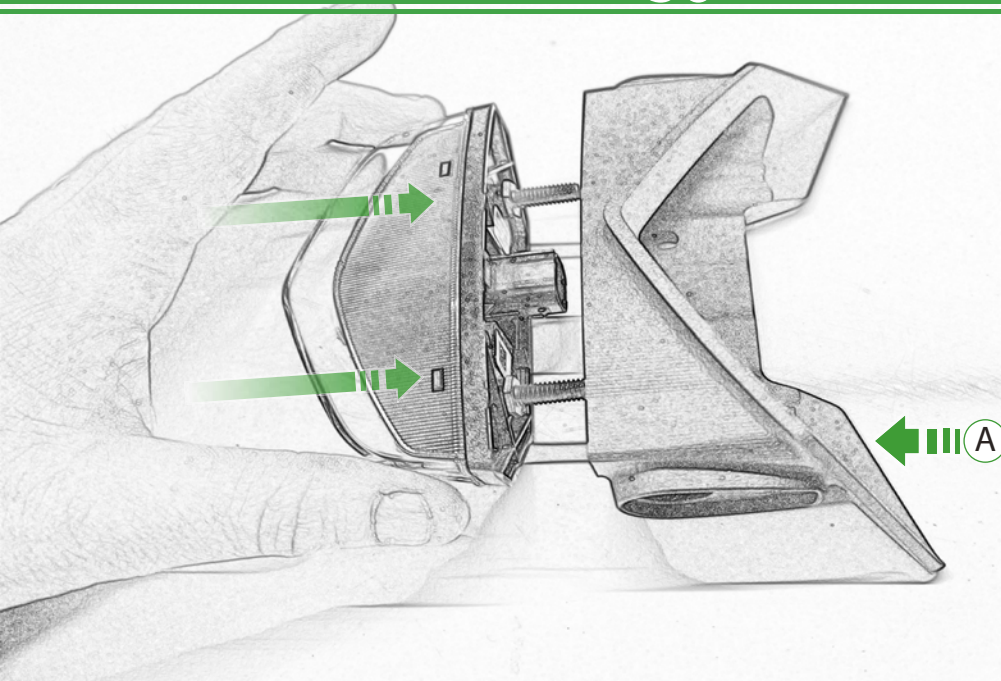

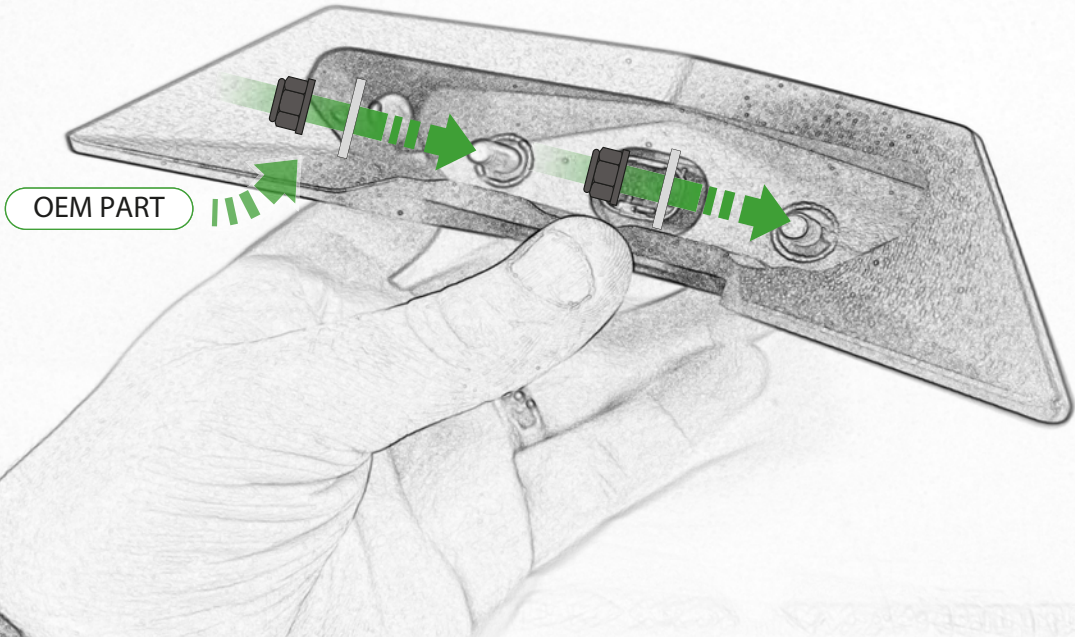

OEM PART

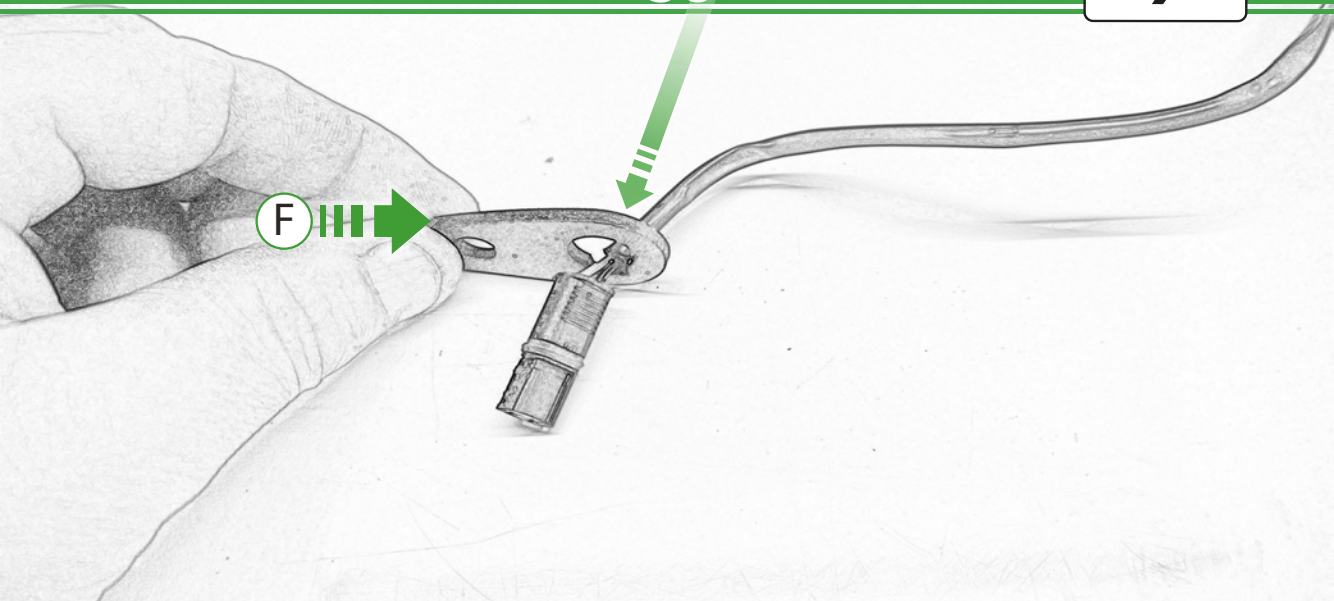

Repeat
Both Sides

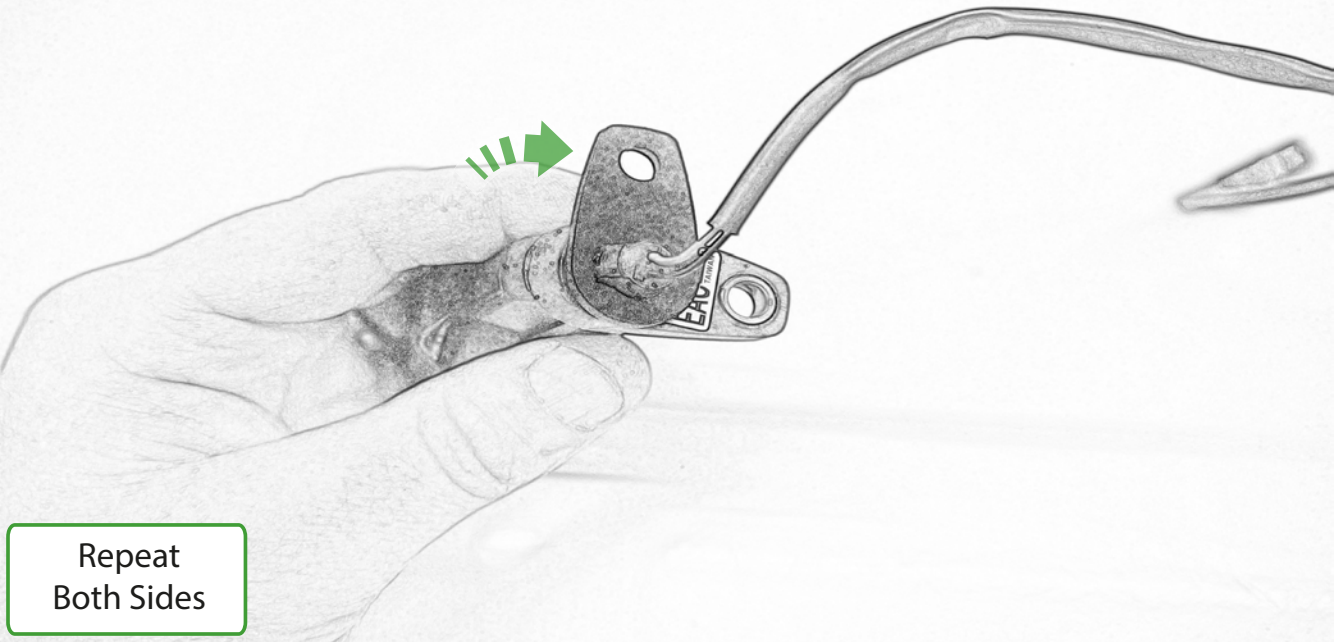

Repeat
Both Sides

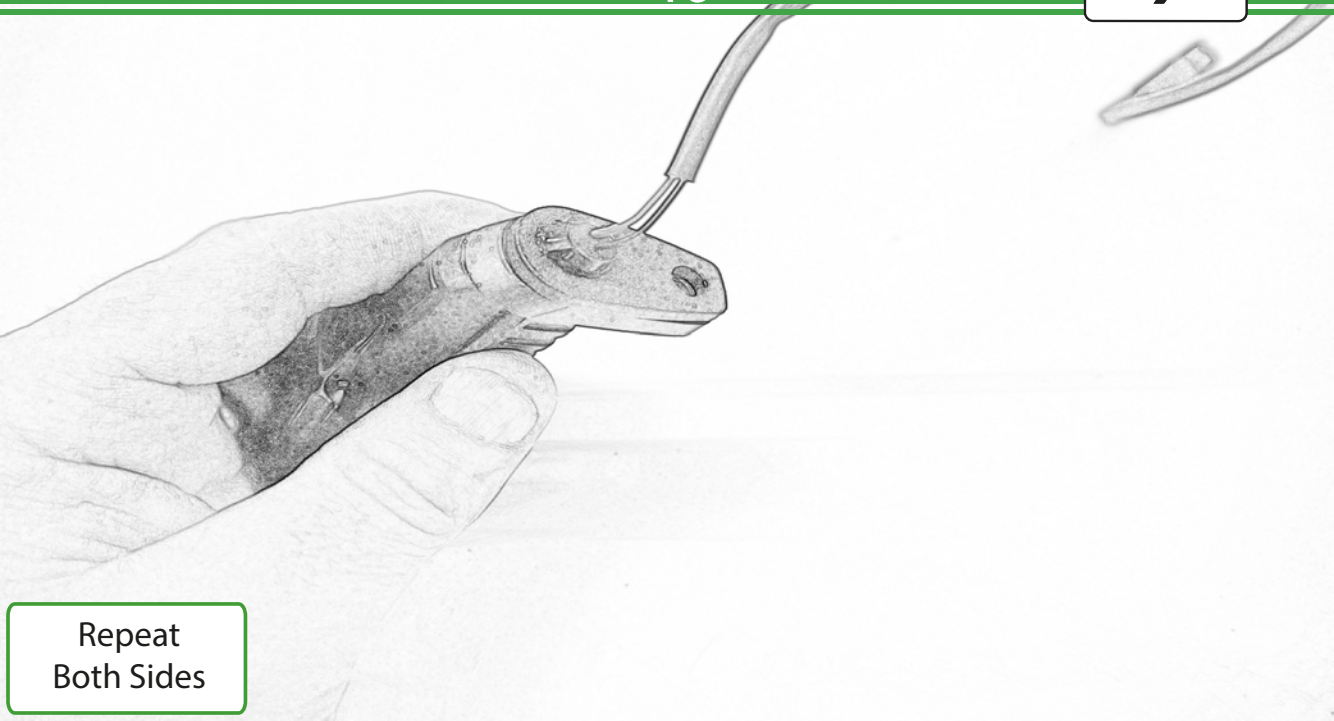

Repeat
Both Sides

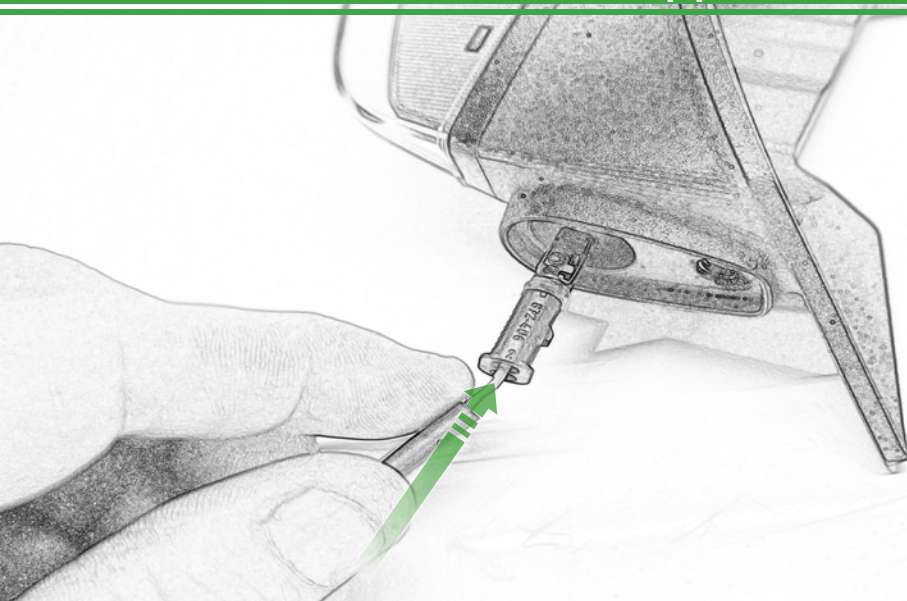

Repeat
Both Sides

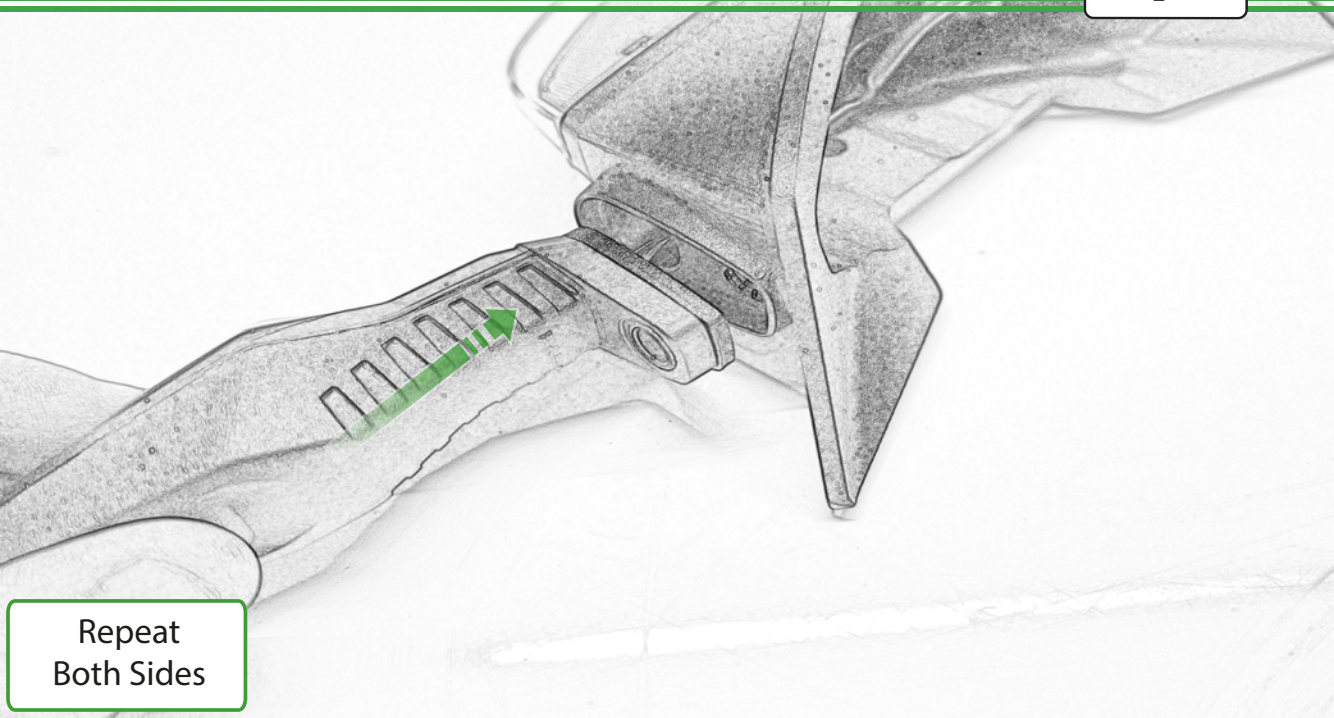

Repeat
Both Sides

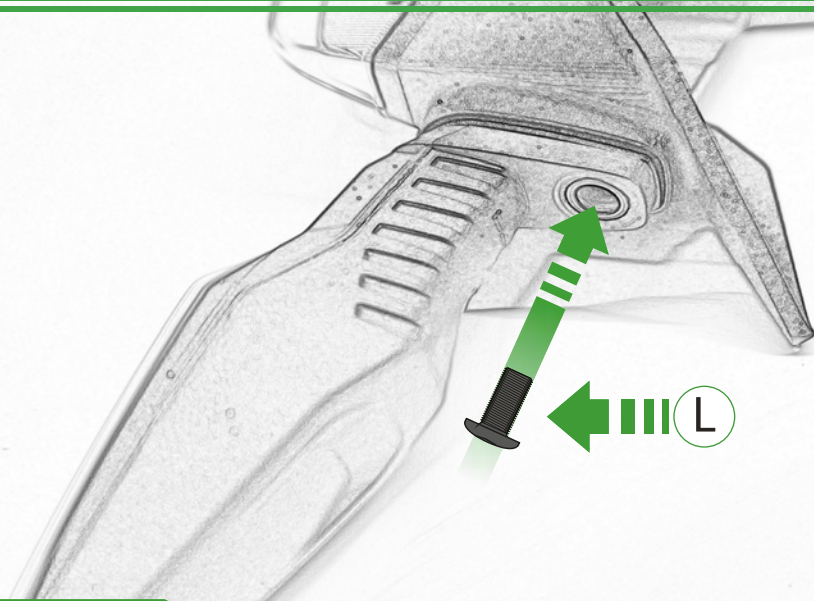

Repeat
Both Sides

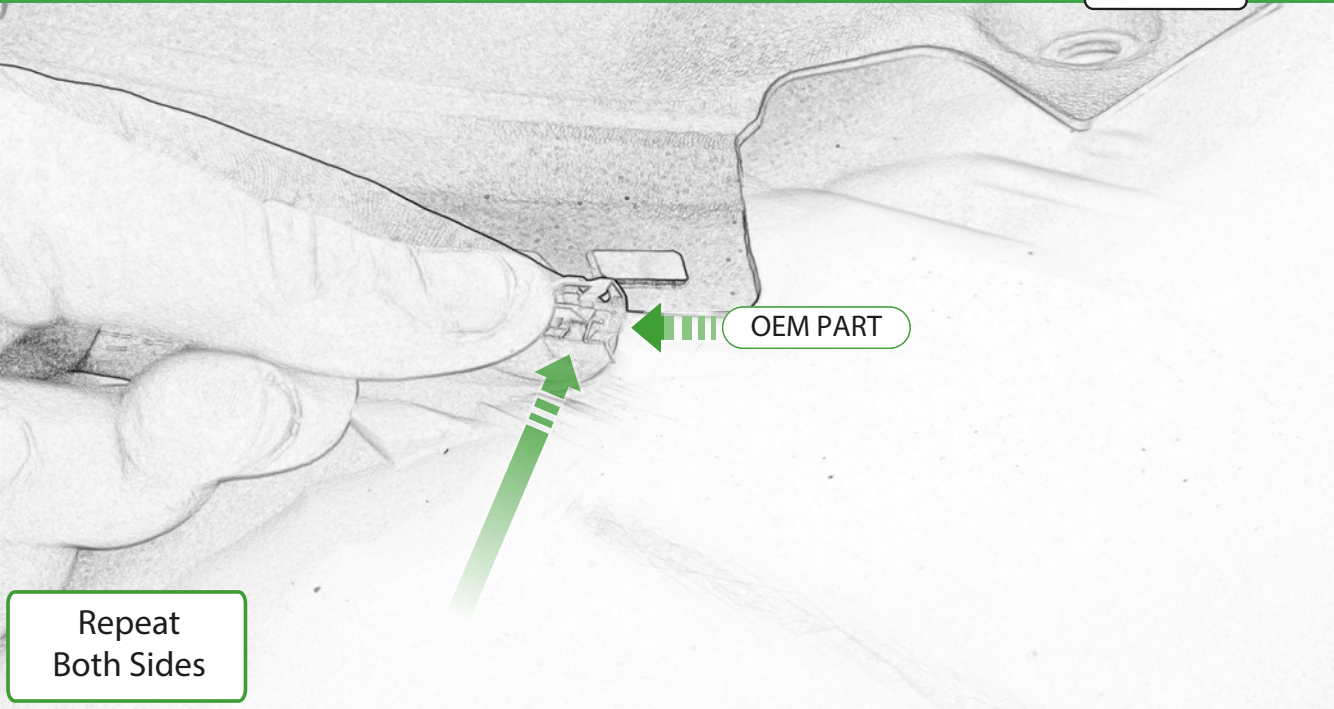

OEM PART

Repeat
Both Sides

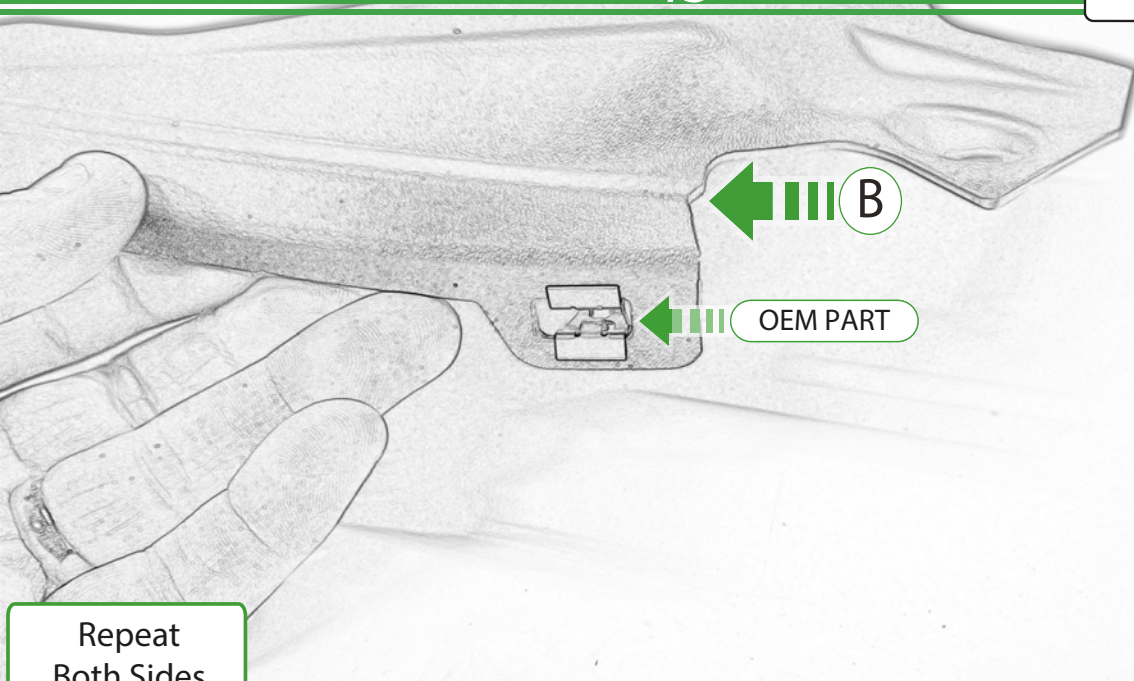

← B

← OEM PART

Repeat
Both Sides

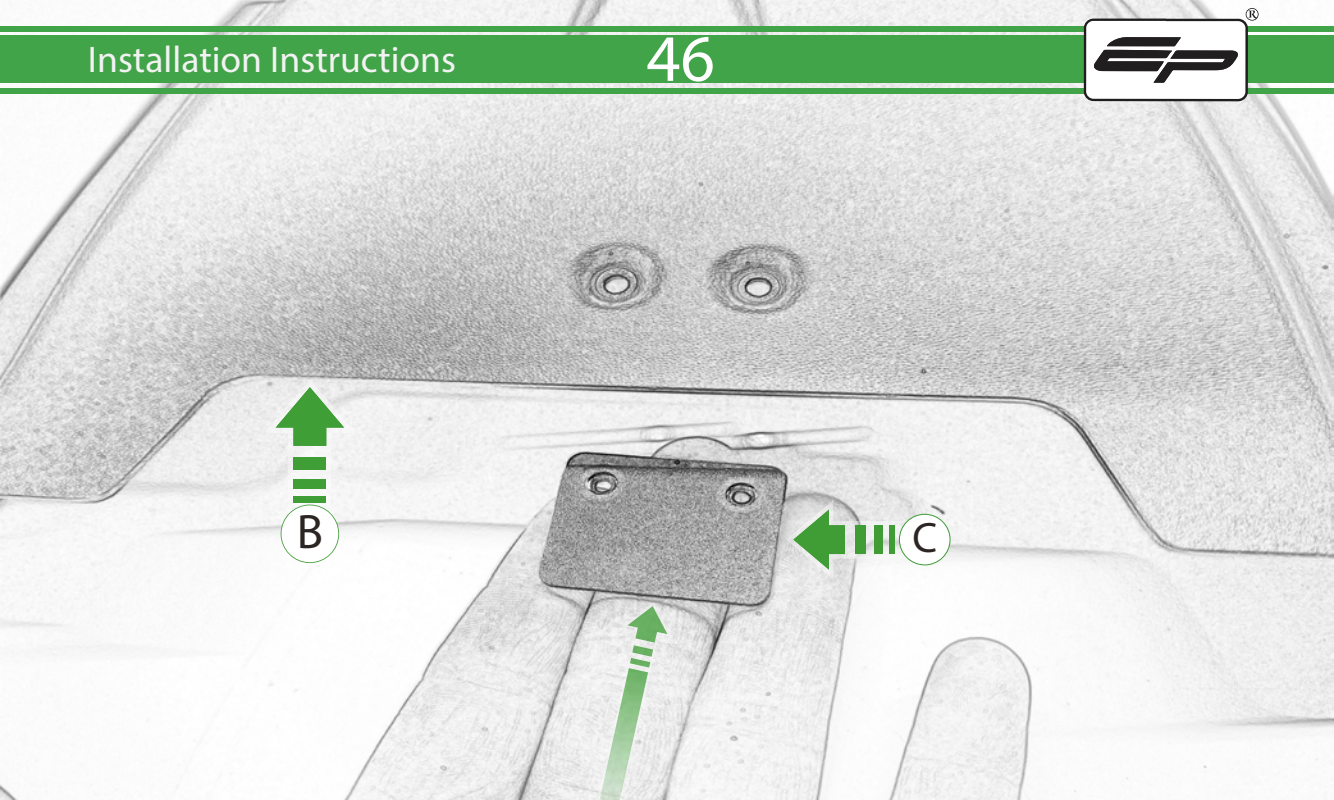

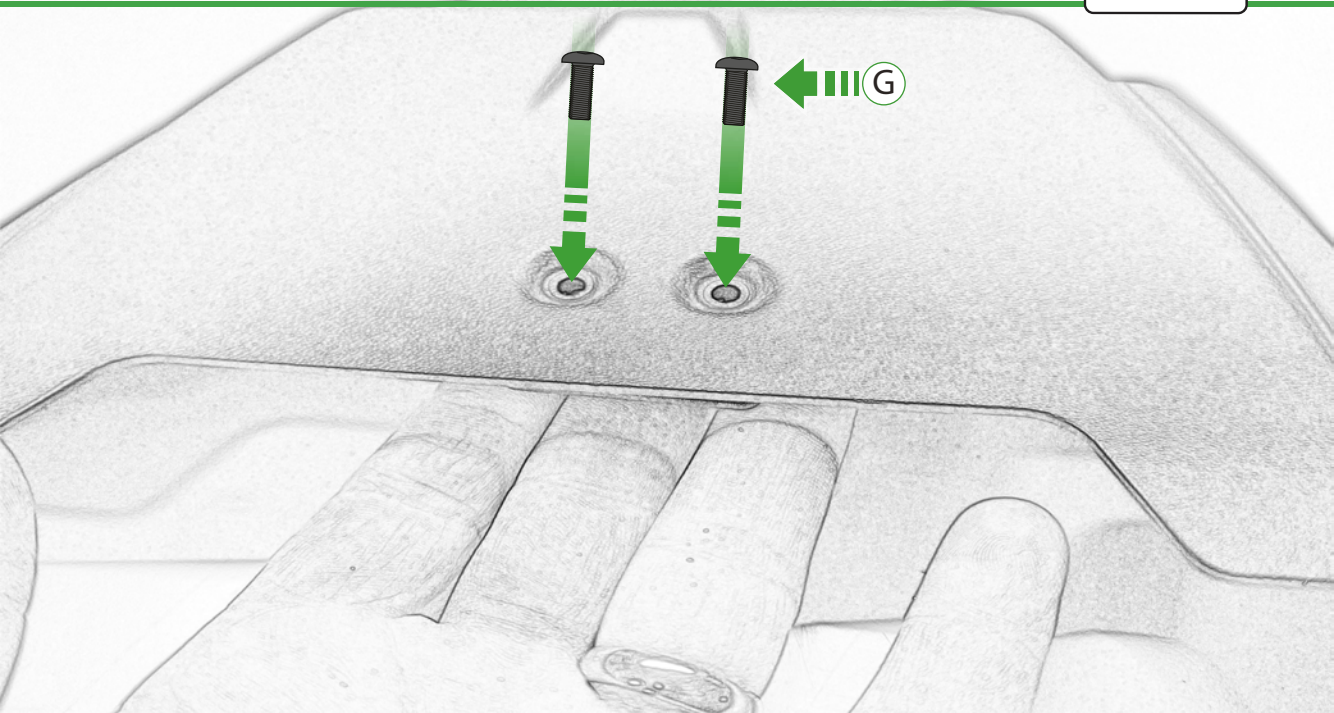

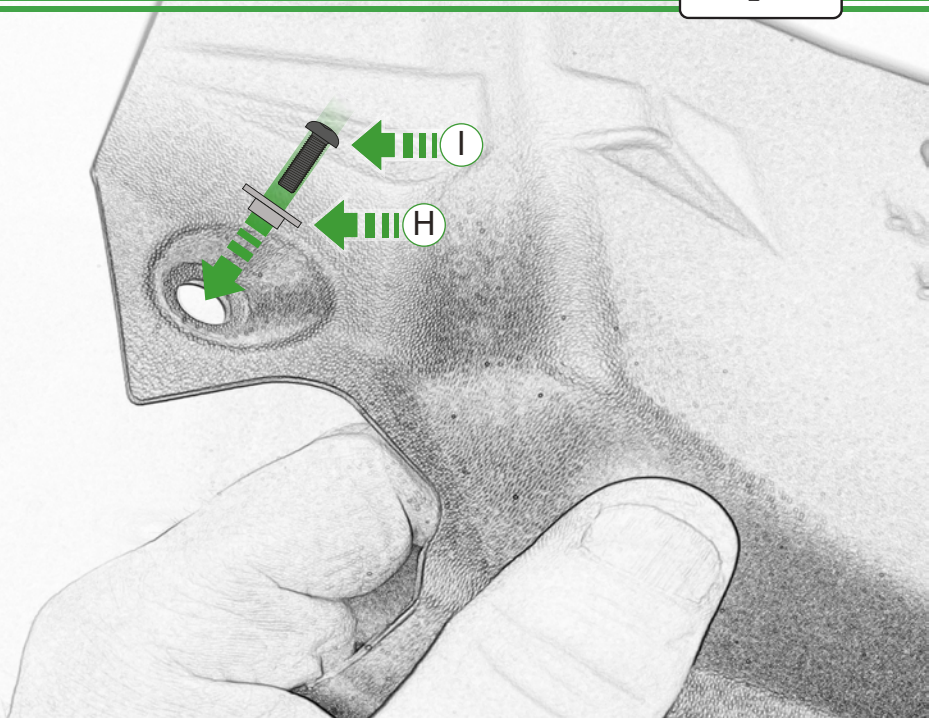

Repeat
Both Sides

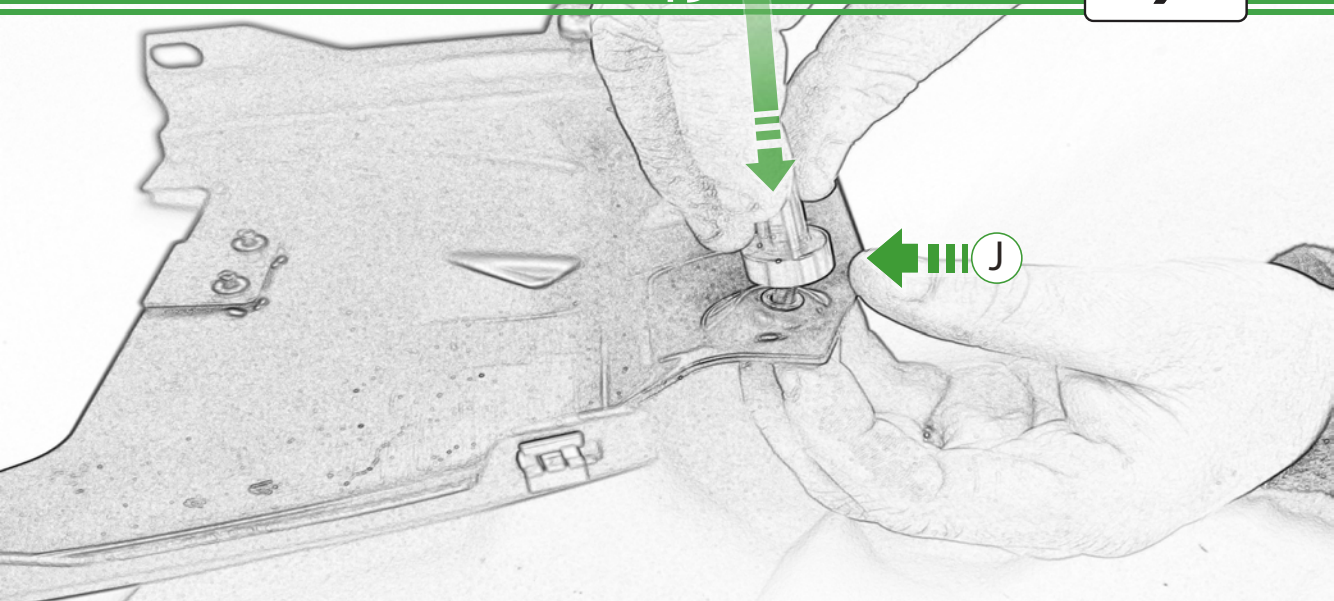

Repeat
Both Sides



Do Not Fully
Tighten

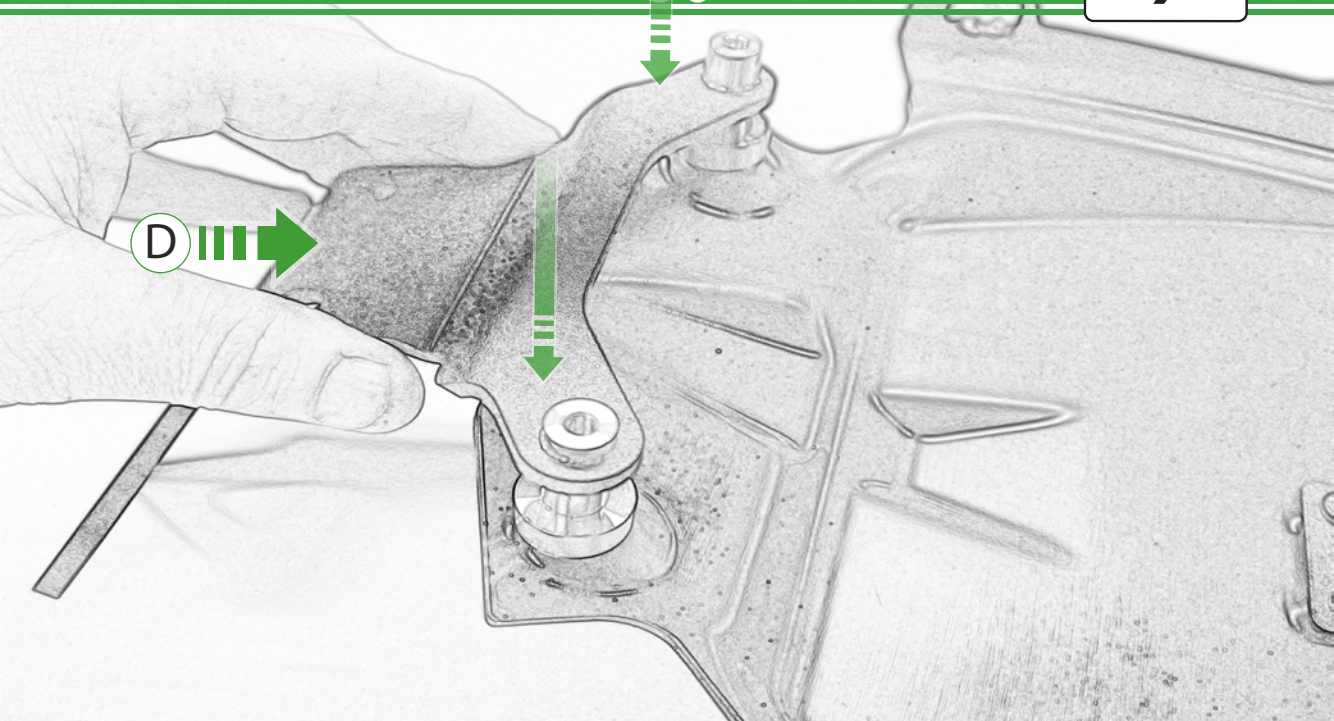

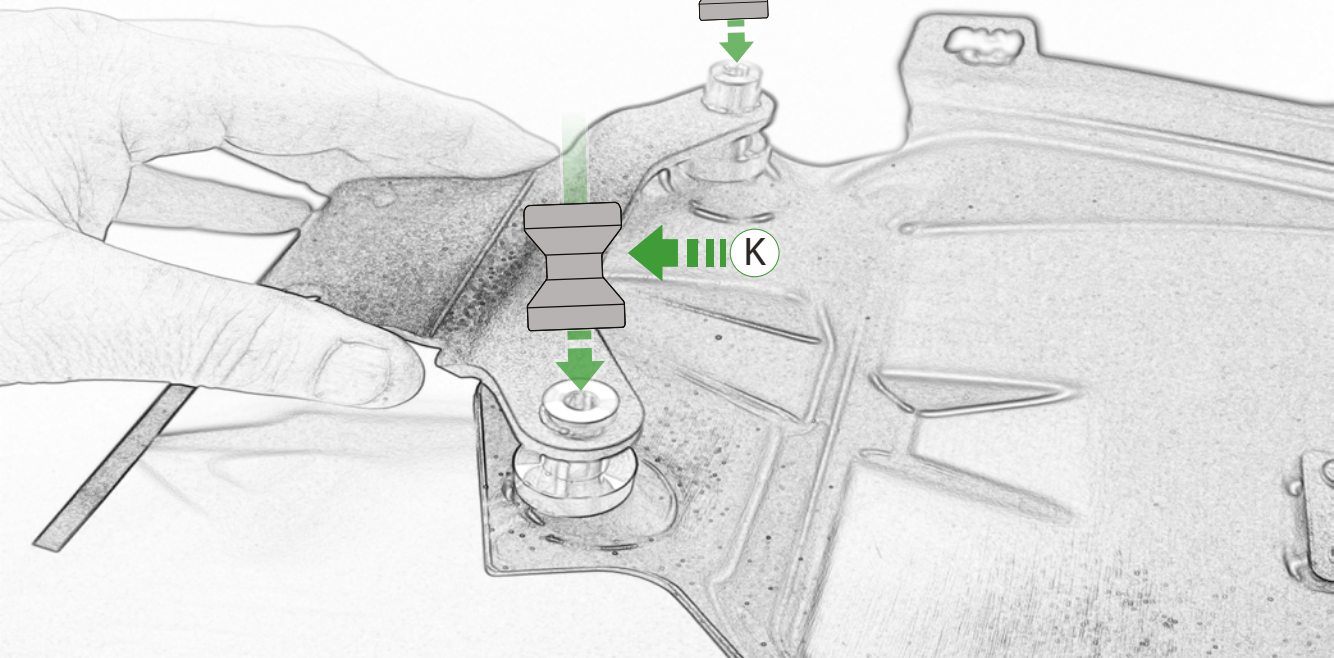

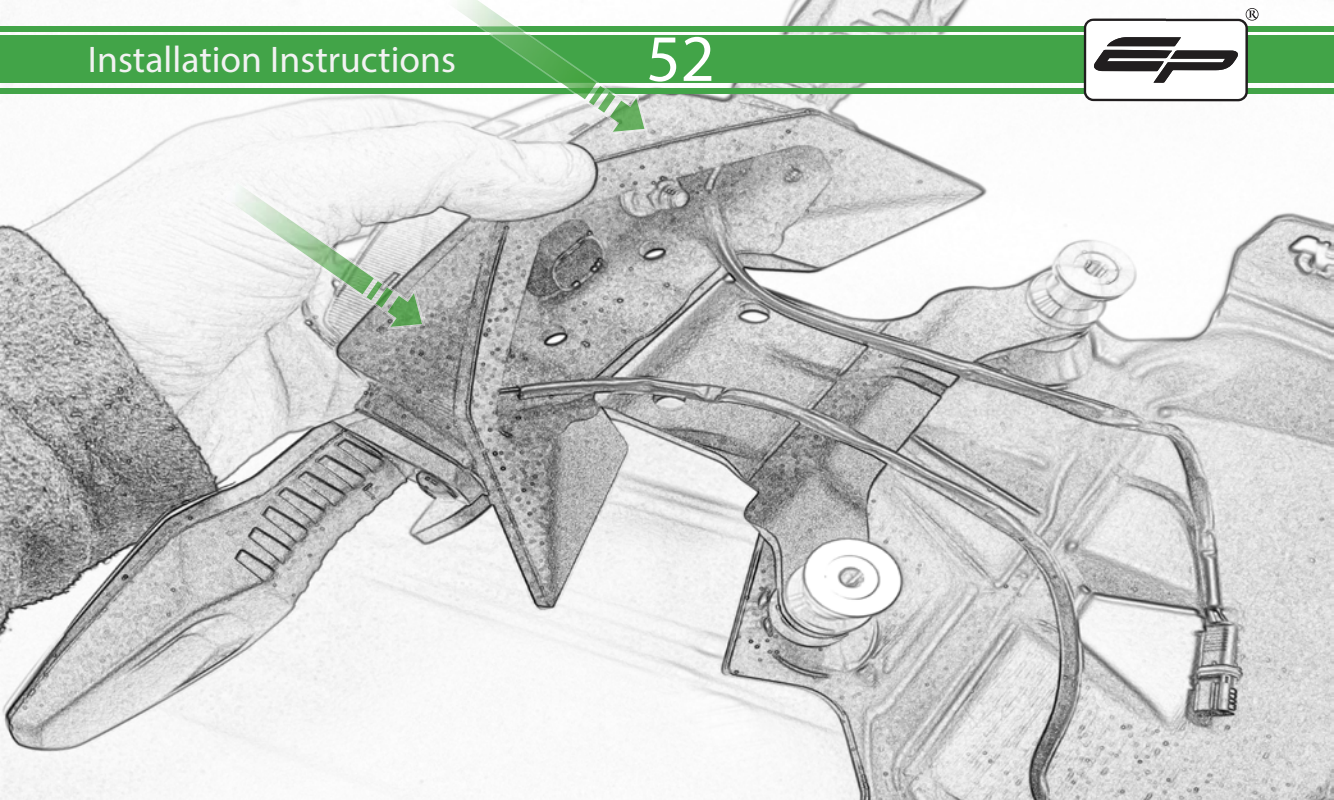

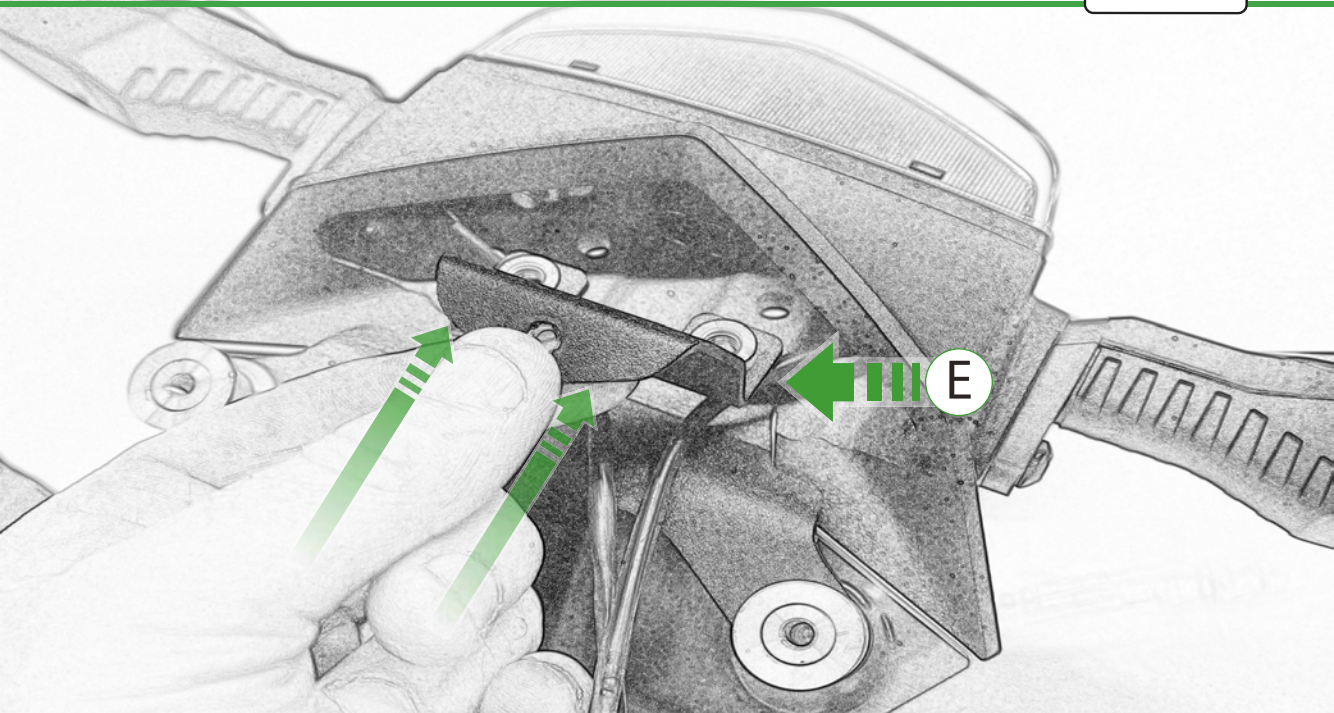

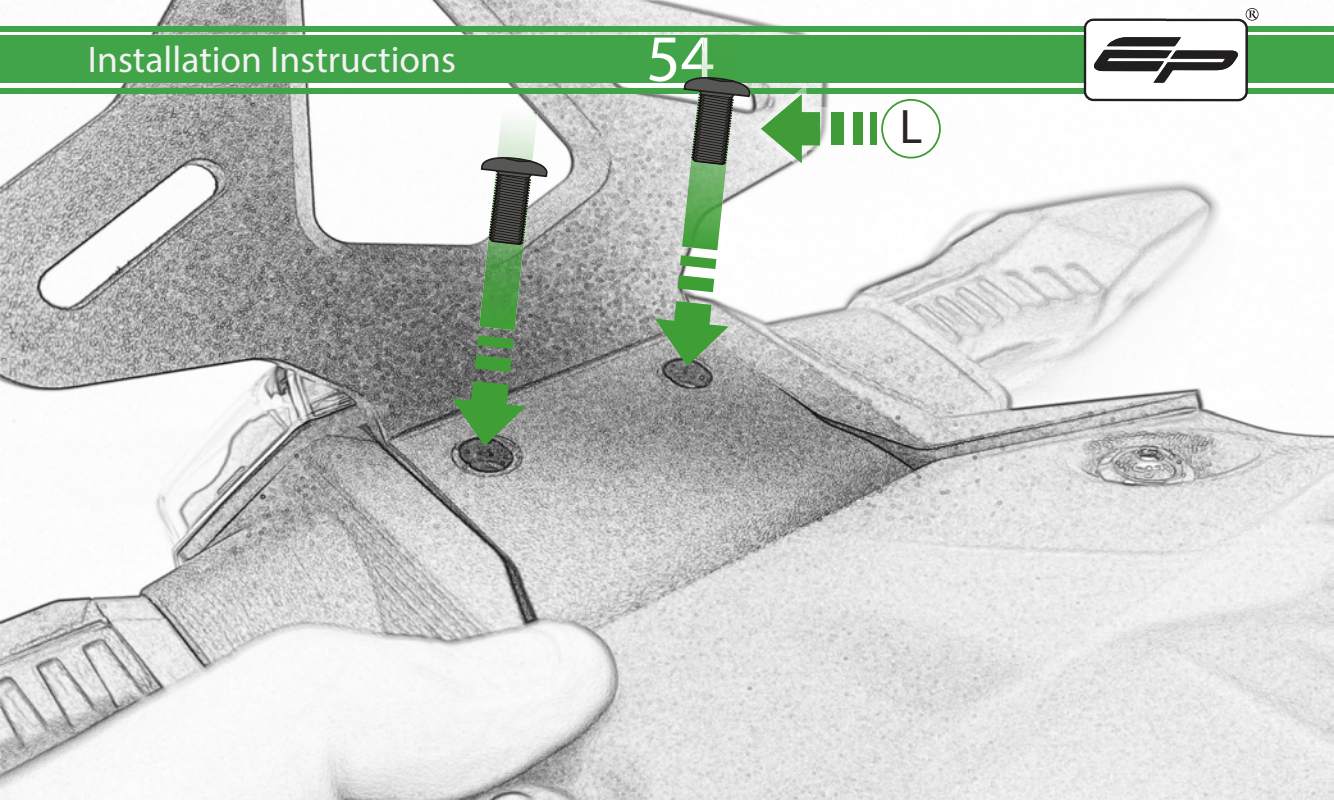

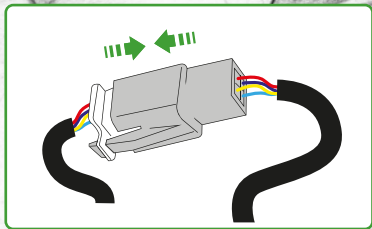
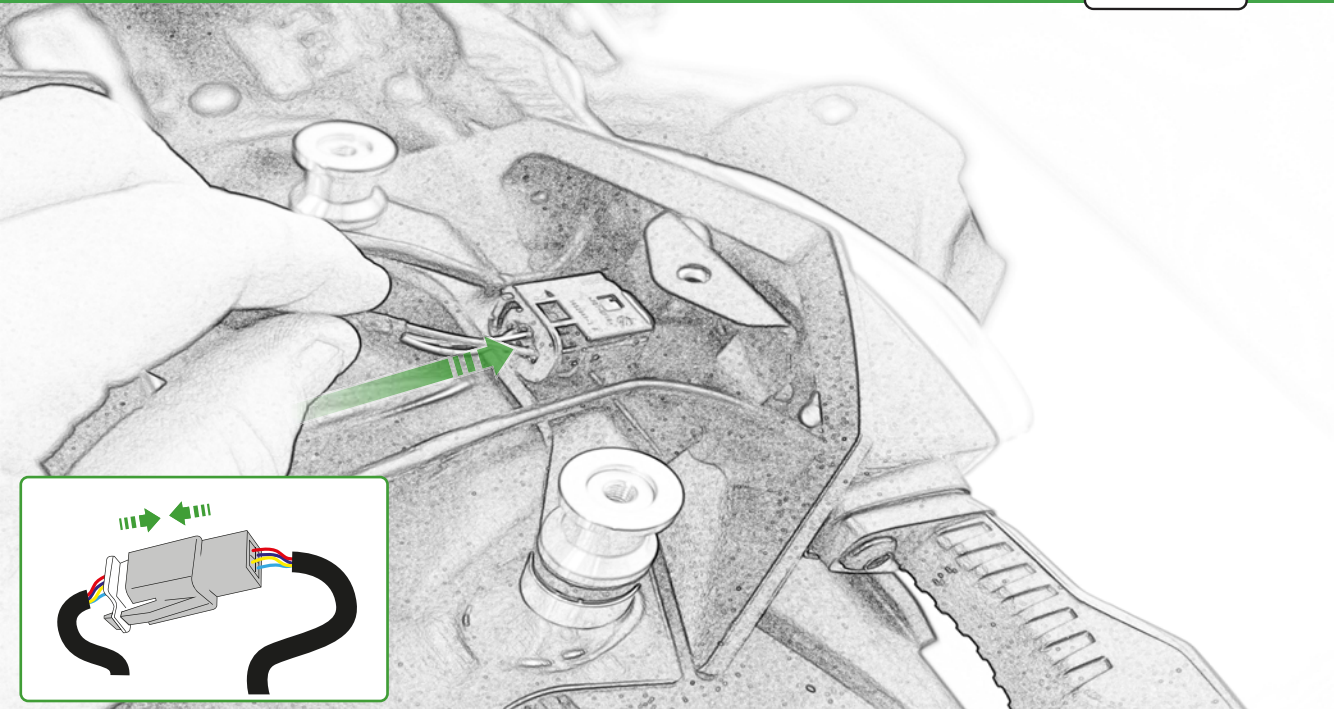

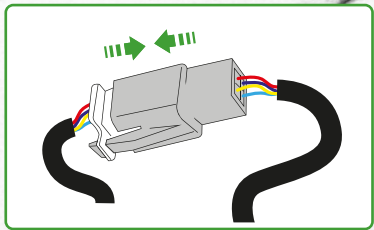
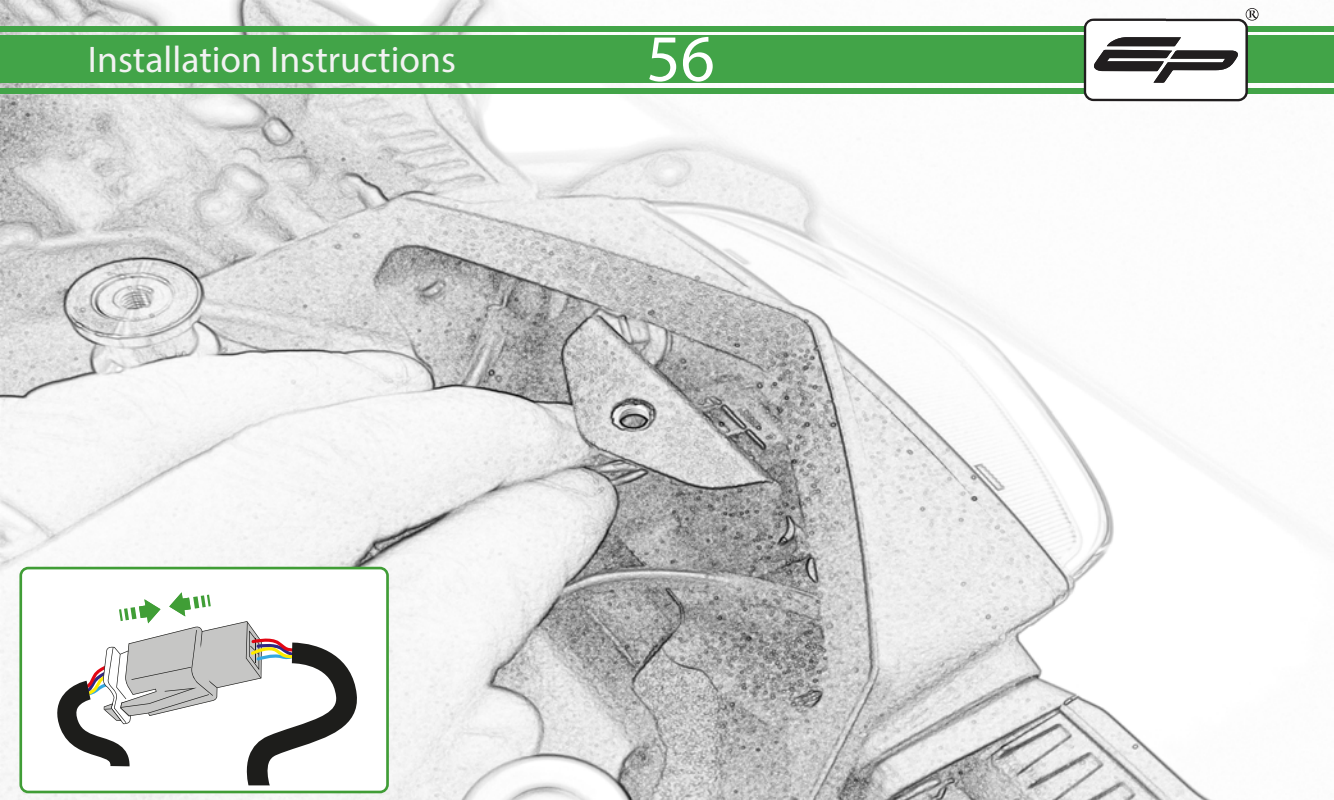

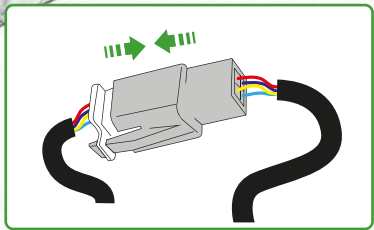
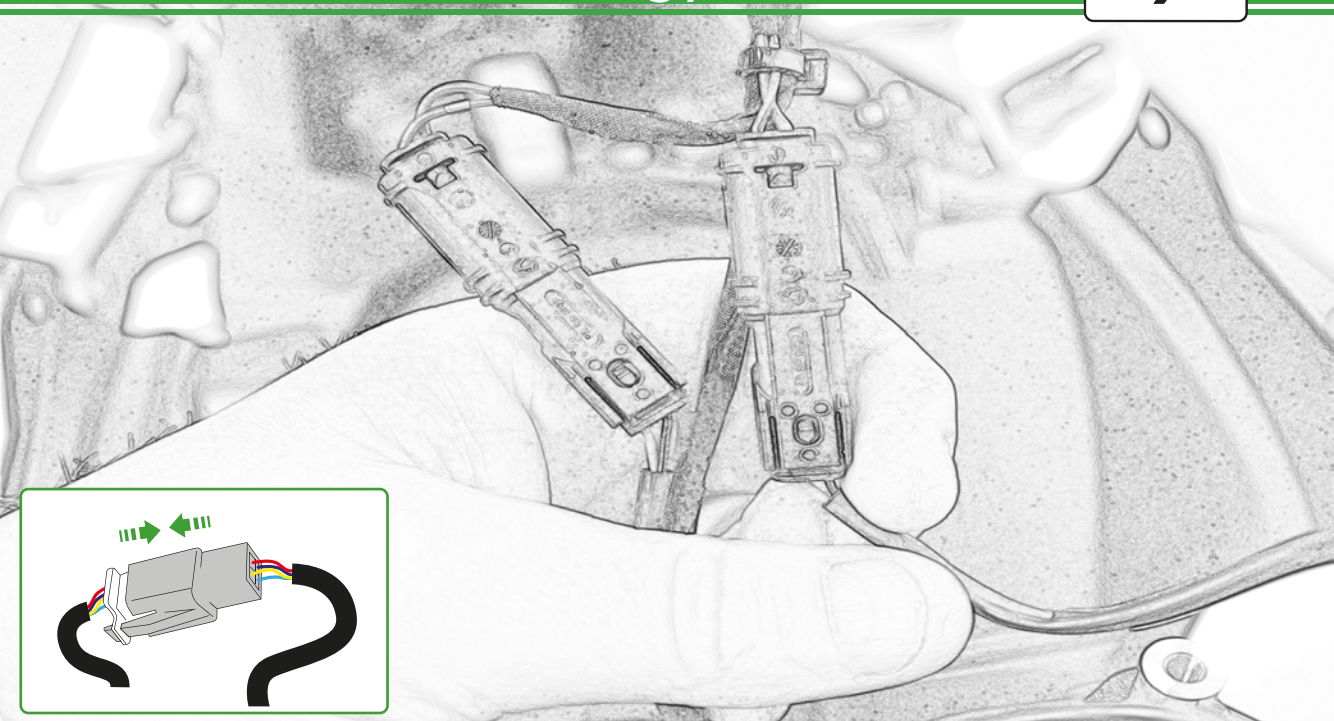

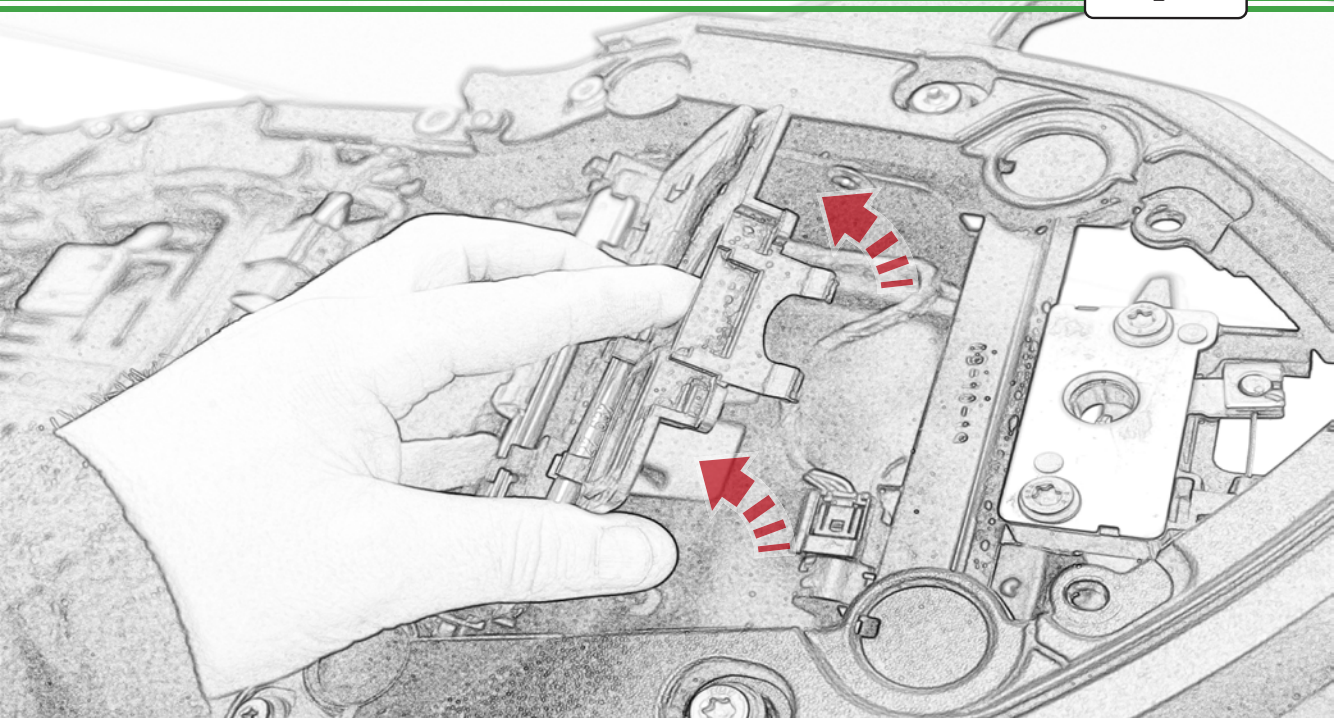

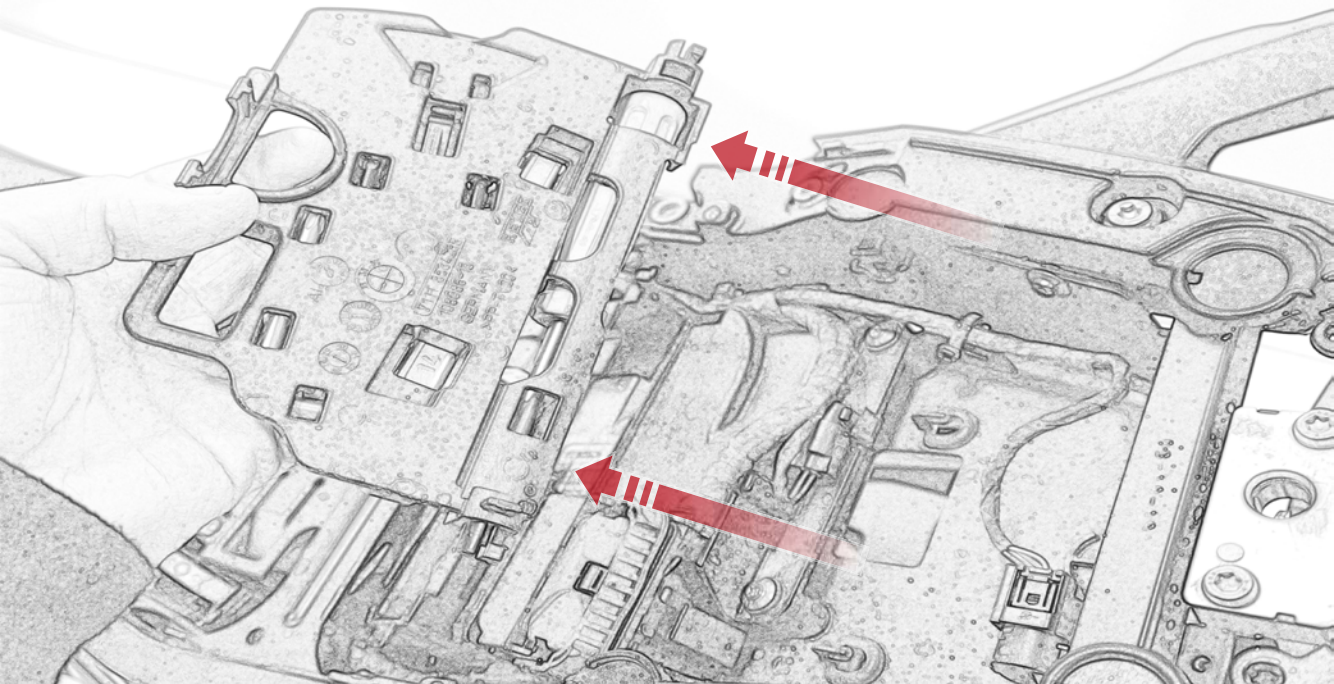



Caution

Locate loom in underseat area
ensuring they do not
get trapped or squashed

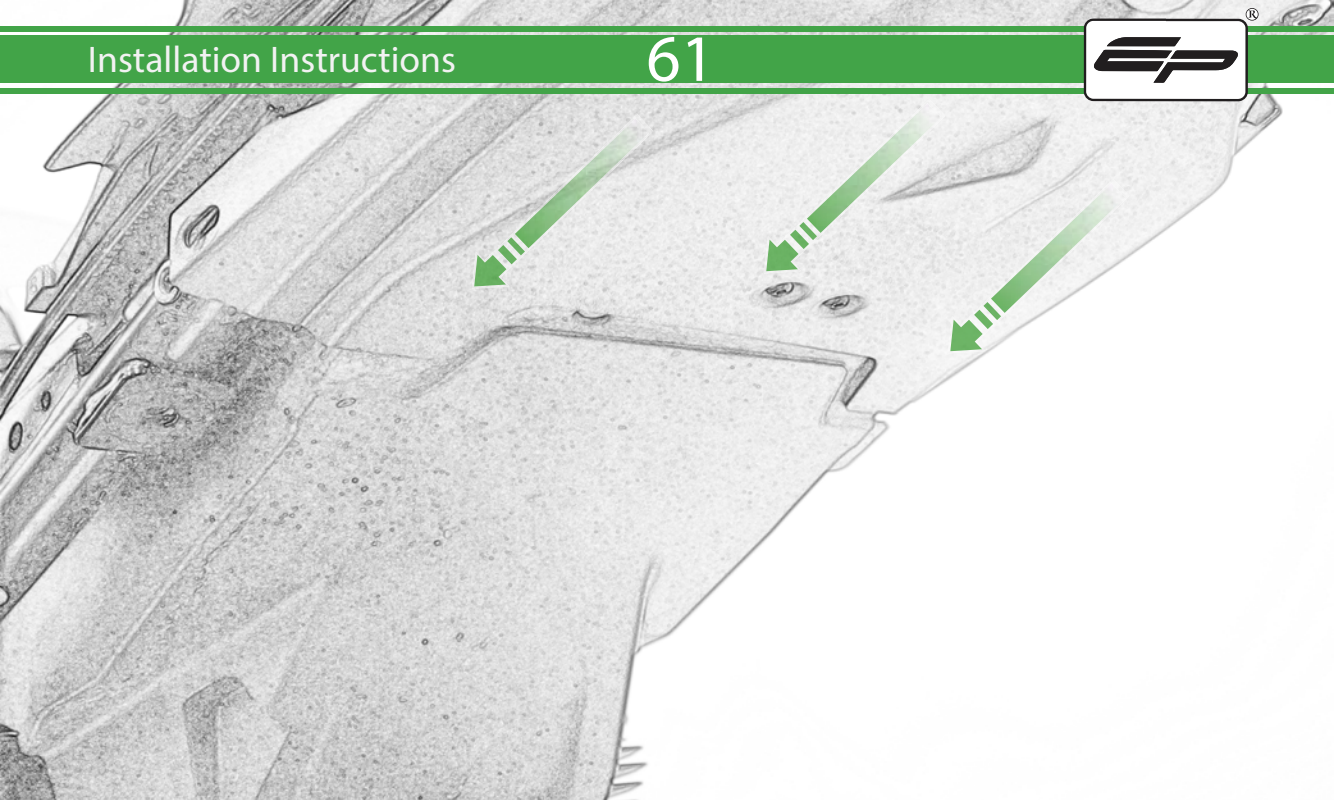

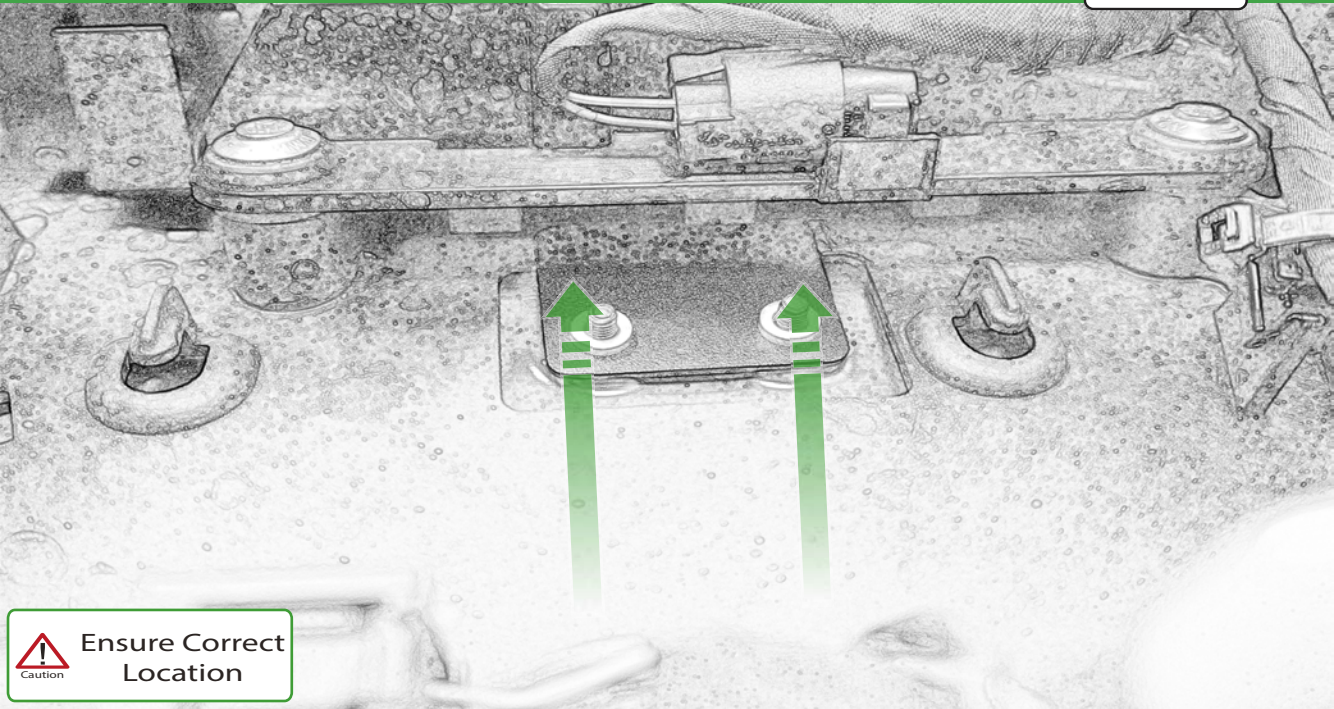

Ensure Correct
Location



OEM PART

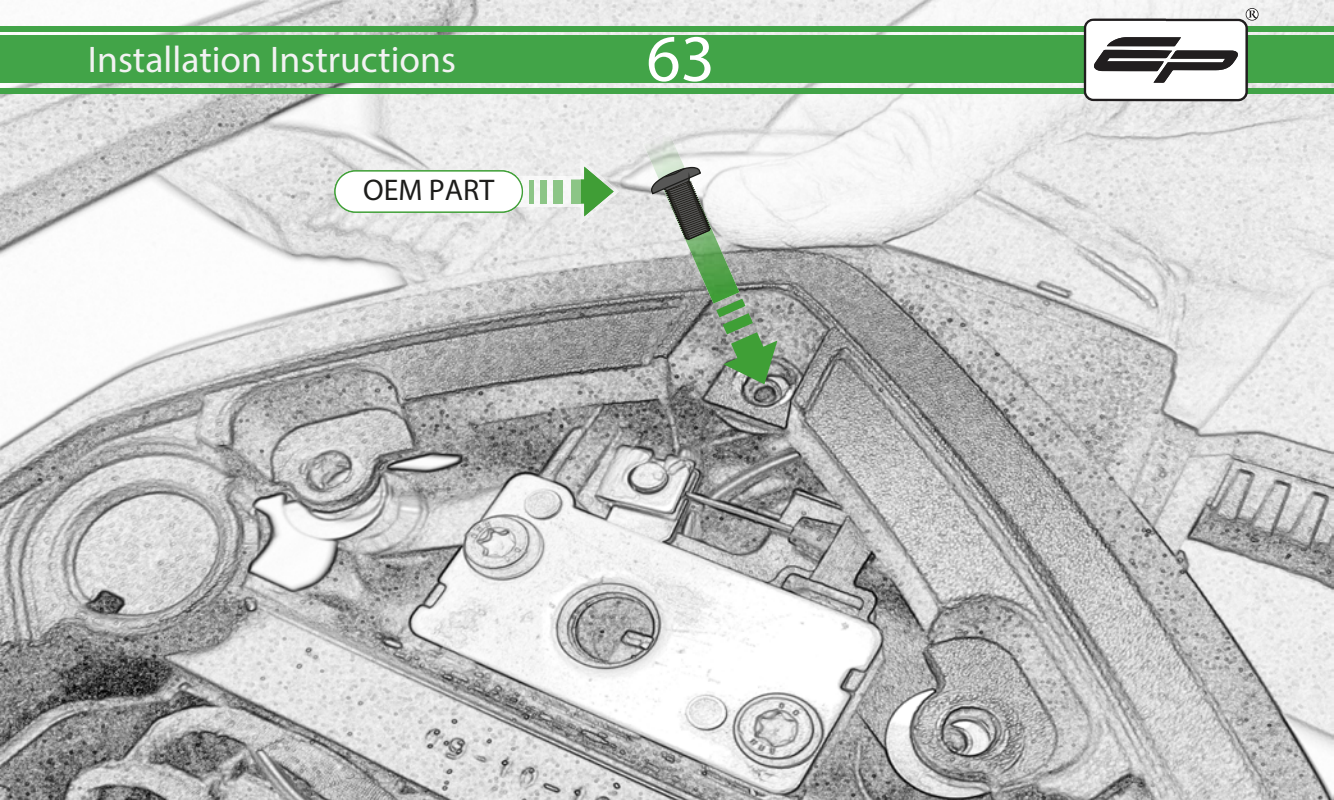
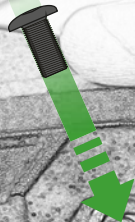

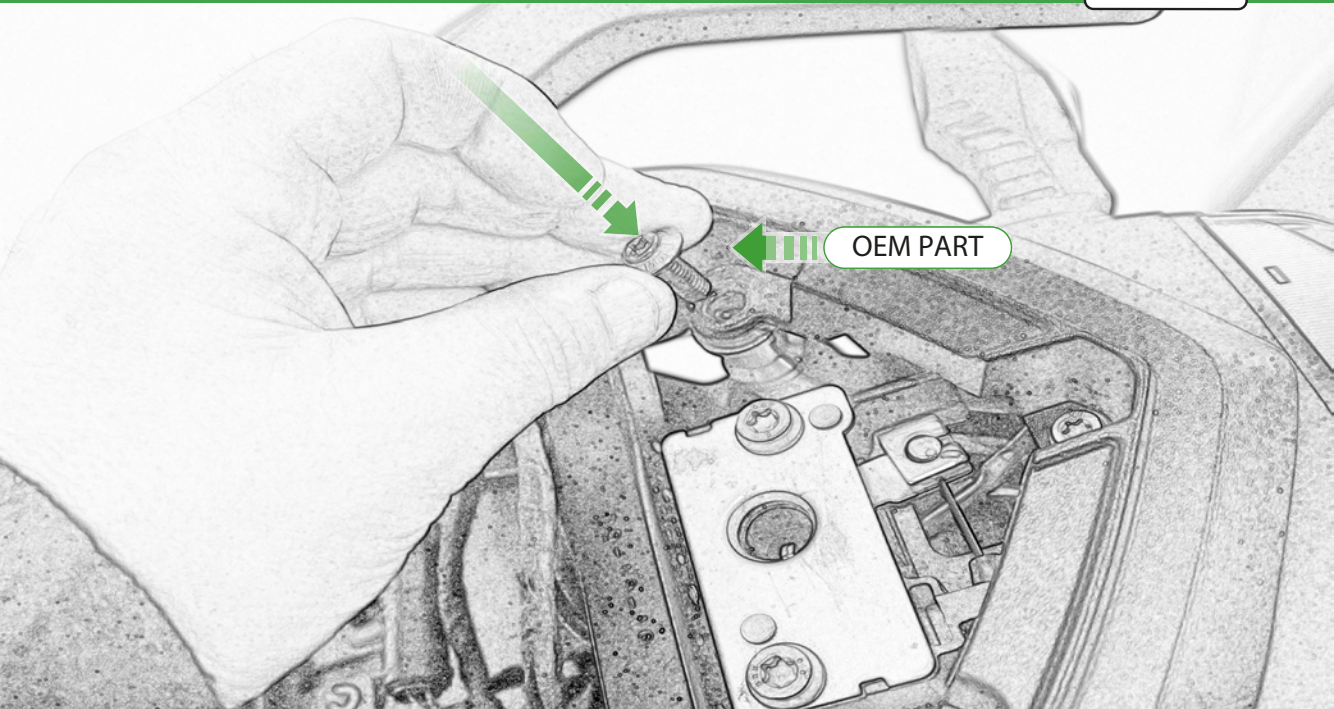

OEM PART

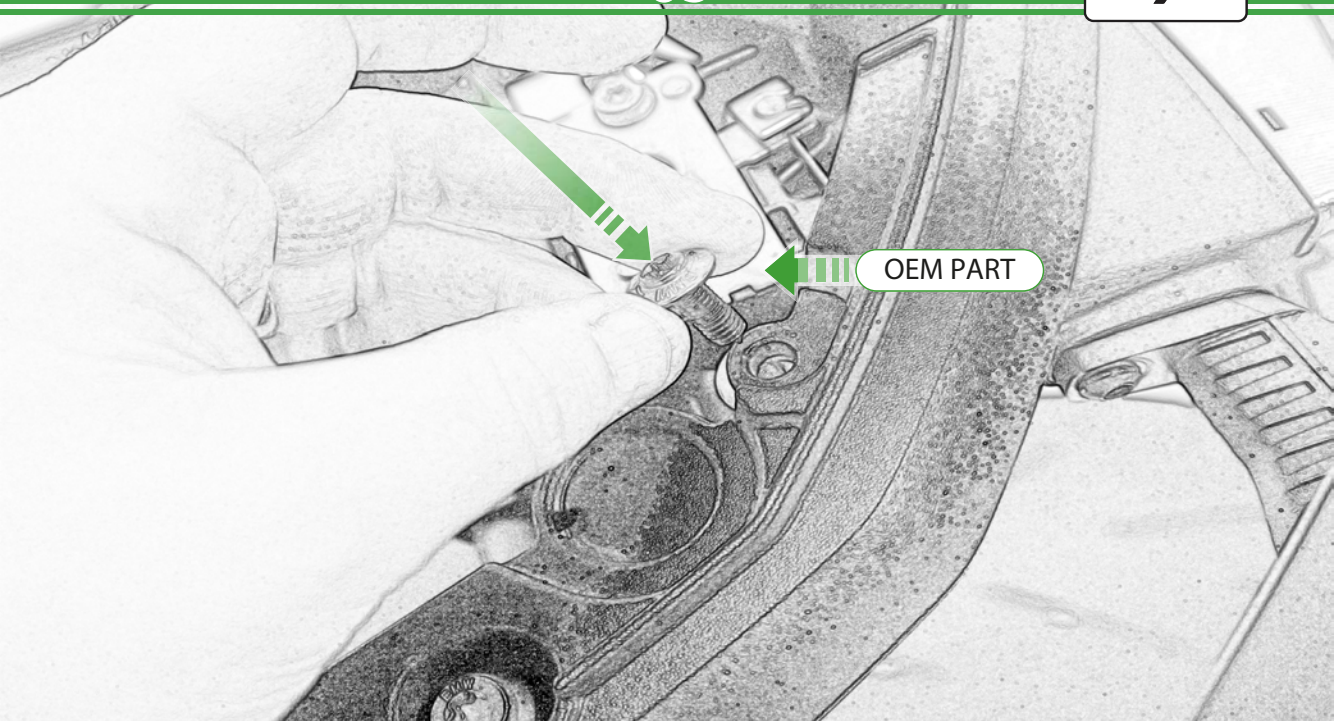

OEM PART

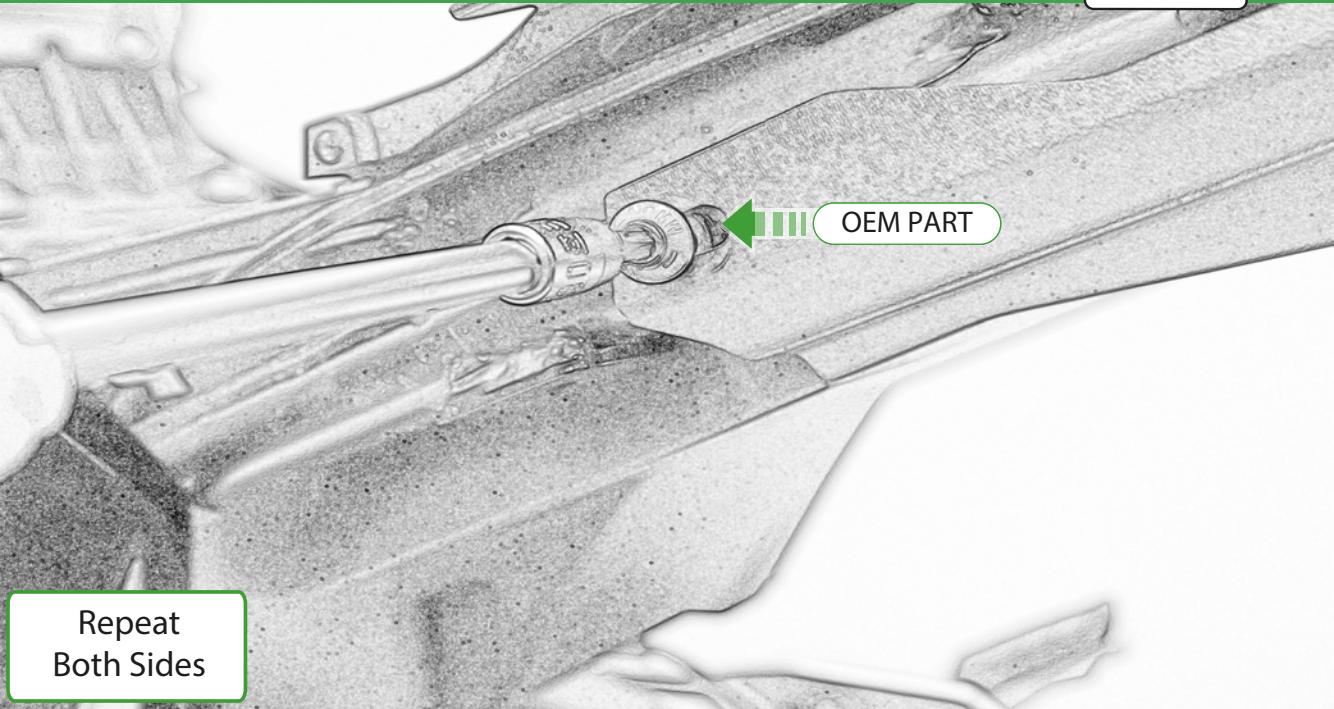

OEM PART

Repeat
Both Sides

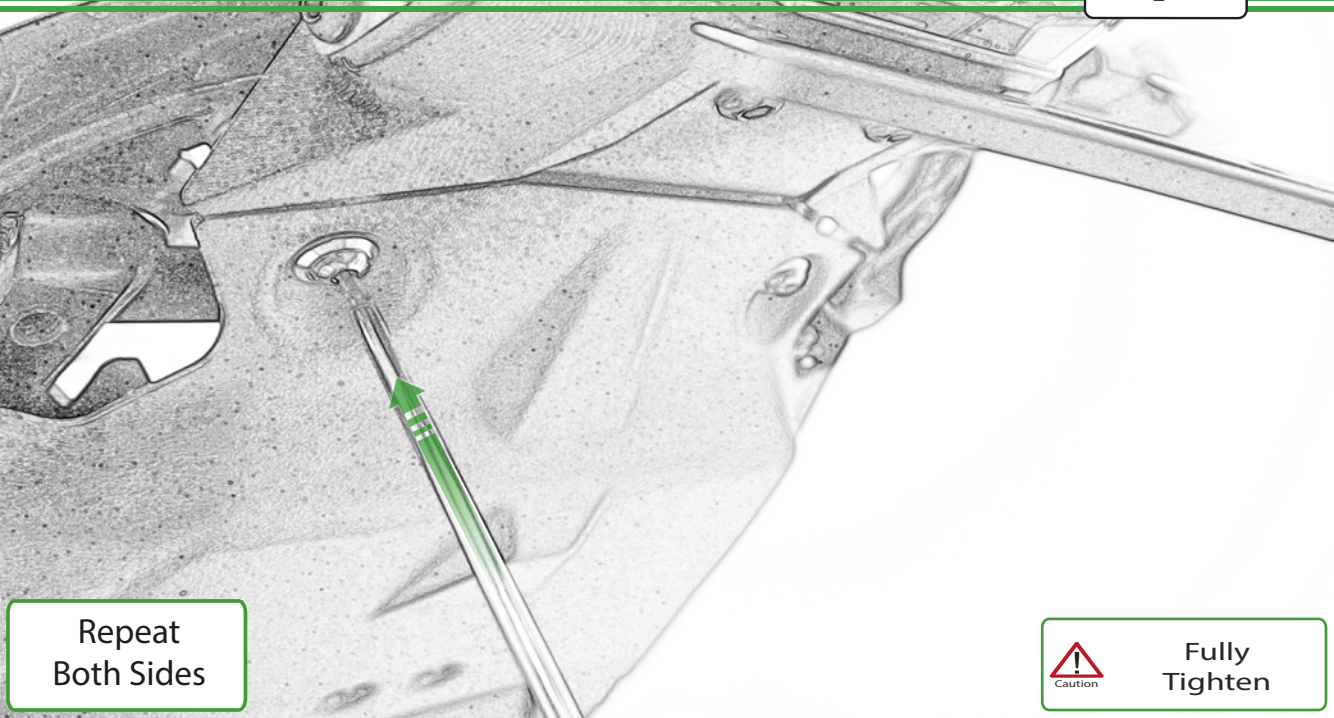

Repeat
Both Sides



Fully
Tighten

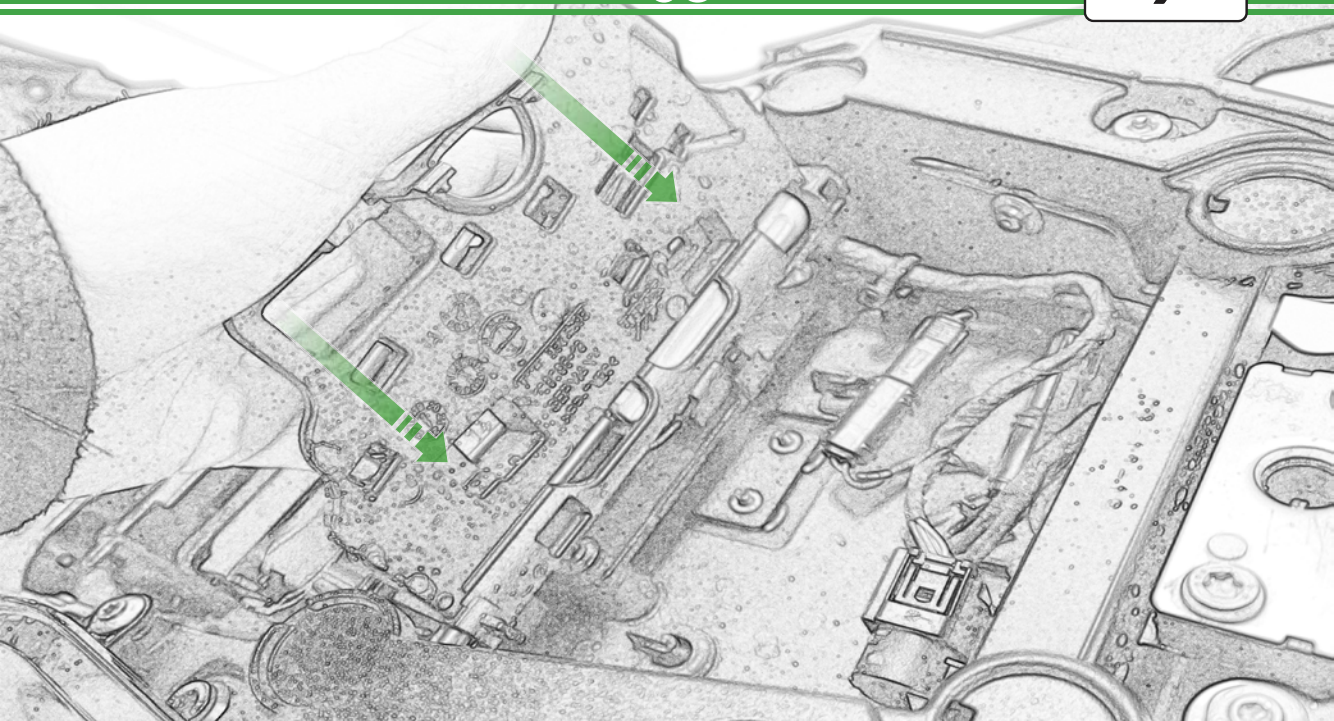

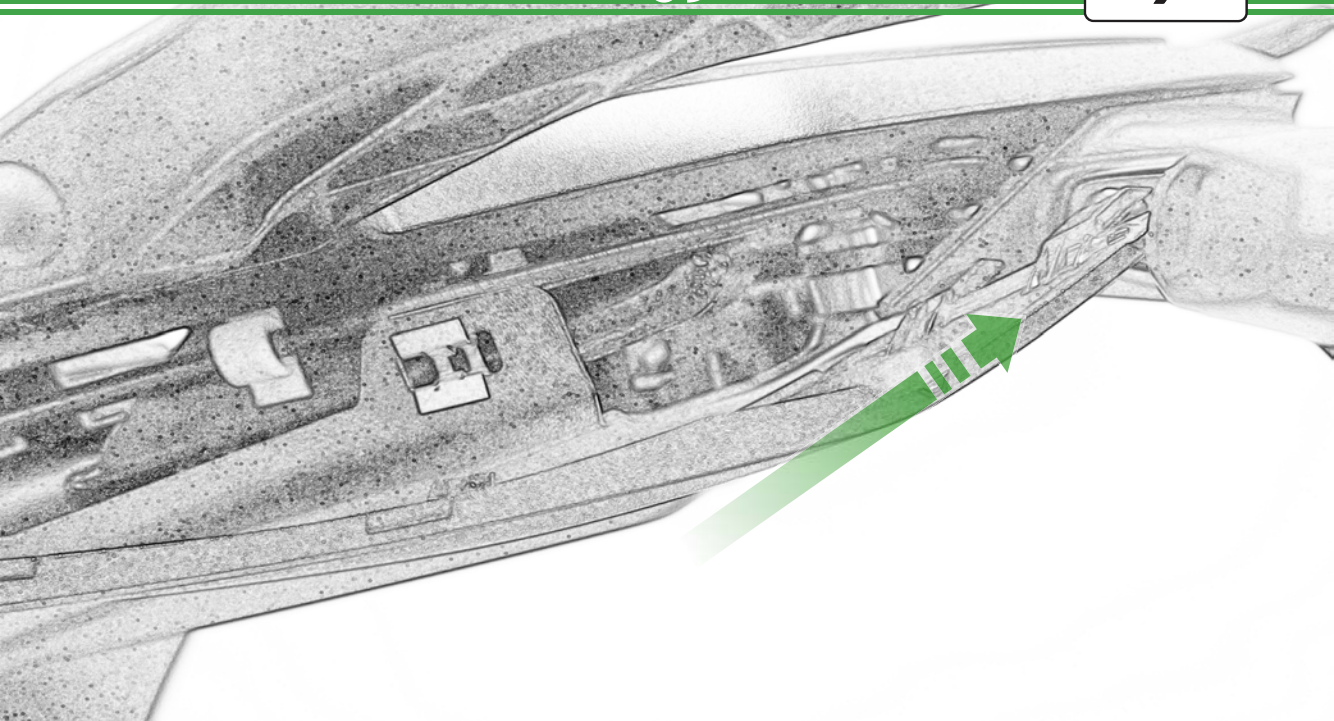

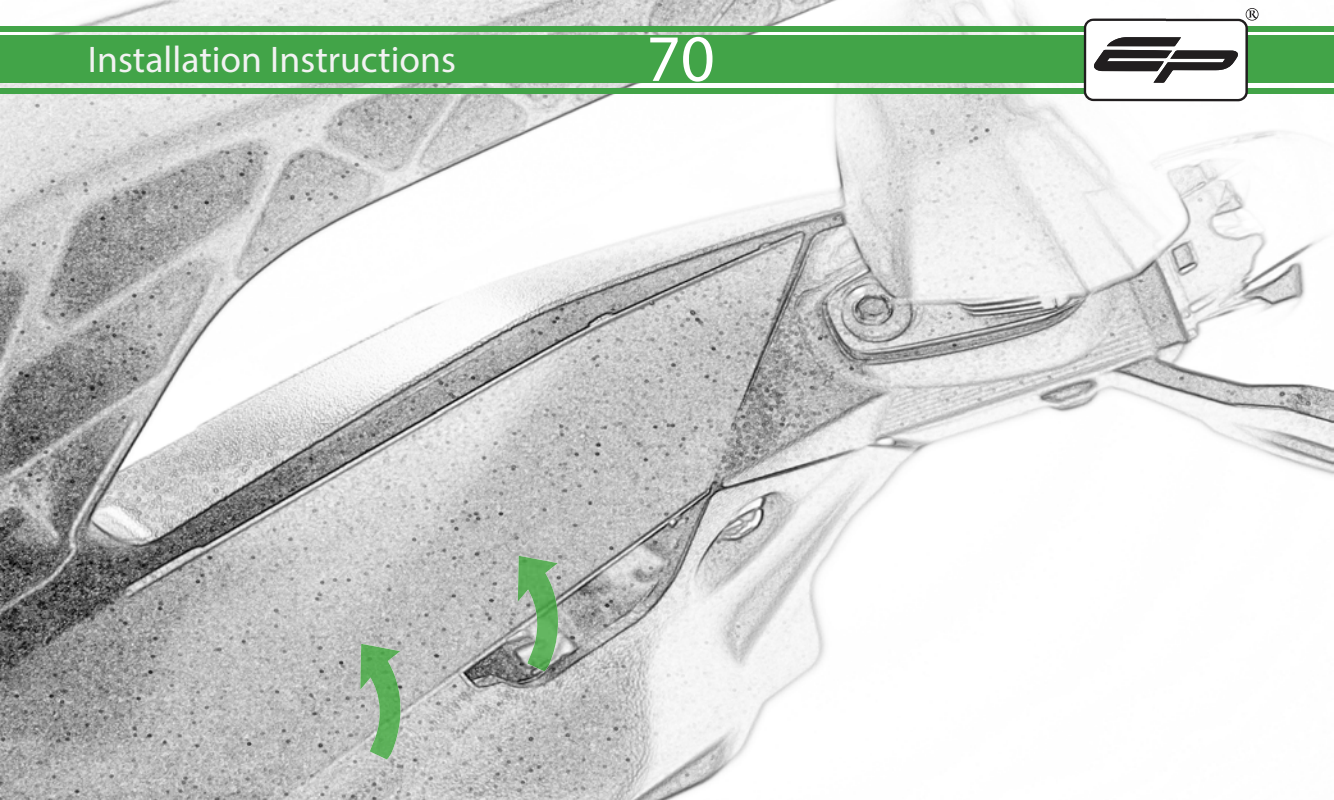

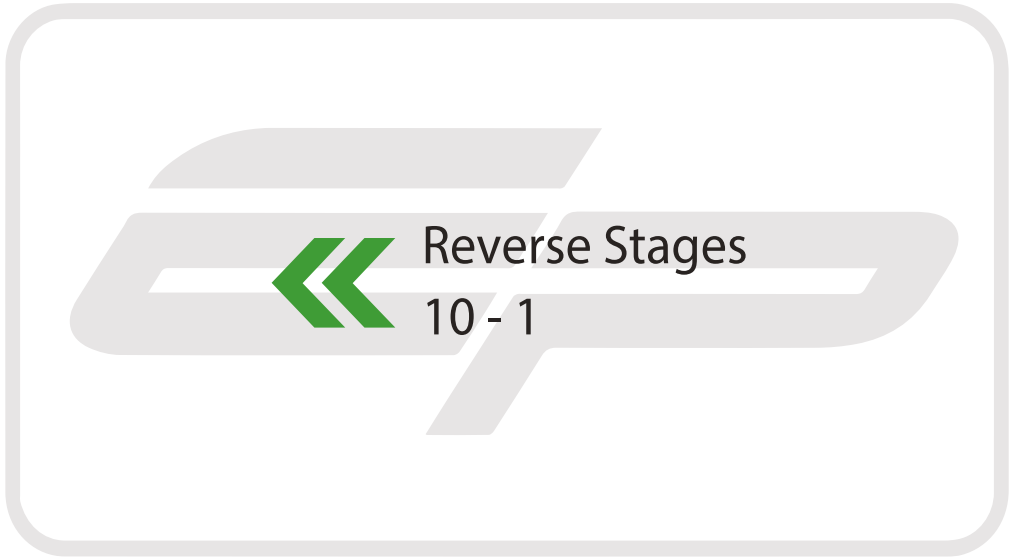

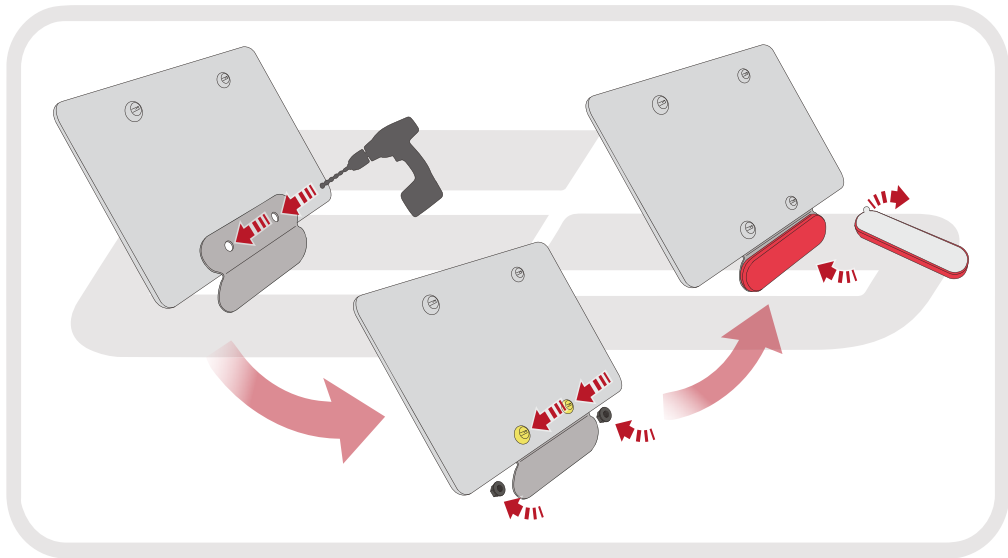

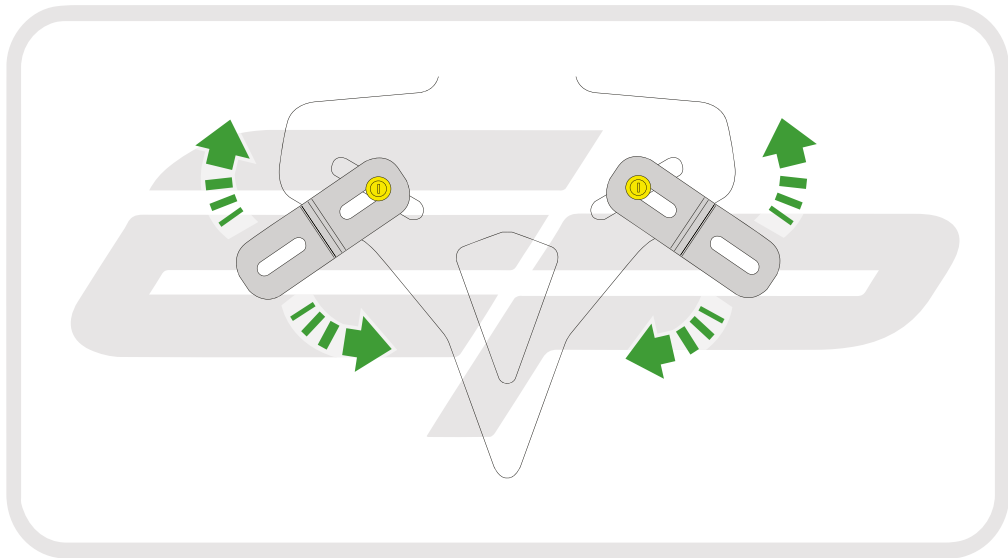



ESSENTIAL CHECKS



After installation of your tail tidy ensure that the licence plate does not contact the rear tyre when suspension is fully compressed.

Ensure all electrics including indicators, tail light, brake light and licence plate light lights are working correctly before riding the motorcycle.

It is recommended that periodic inspections are made to ensure that all fixings are fully tightend.



EVOTECH®
P E R F O R M A N C E

www.evotech-performance.com