



**EVOTECH**®  
P E R F O R M A N C E

Ducati Diavel 1260  
Garmin Sat Nav Mount

Installation Instructions



## Kit Contents PRN014566-014650

- (A) 1 x Main Plate
- (B) 1 x Pivot Plate
- (C) 1 x Sub Mounting Bracket
- (D) 1 x Garmin Mounting Plate
- (E) 2 x M6 x 16 Button Head Bolts
- (F) 2 x Rubber Washer
- (G) 2 x M5 x 8mm Black Button head Bolts
- (H) 2 x Lobe Screw
- (I) 2 x Locking Washer
- (J) 4 x M4 x 10mm Black Button head Bolts



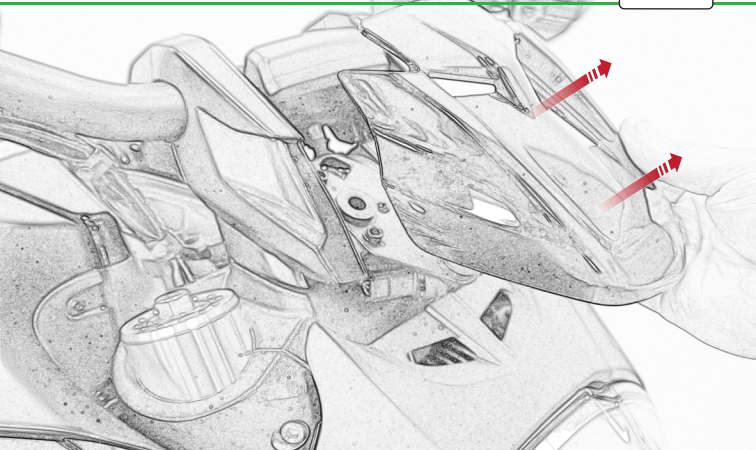



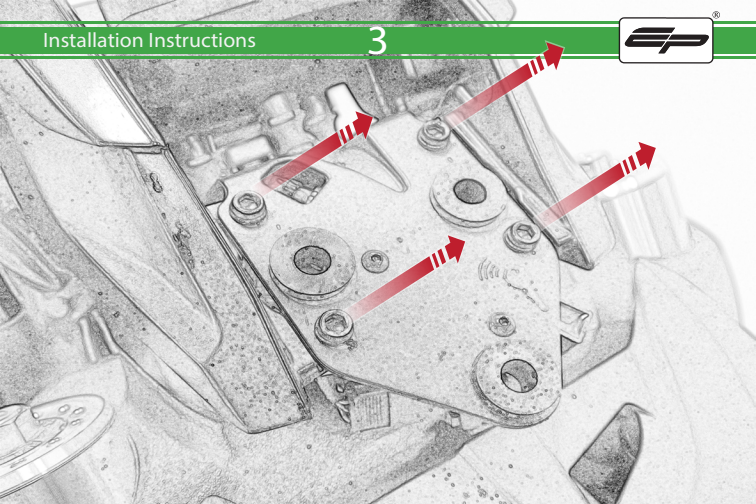

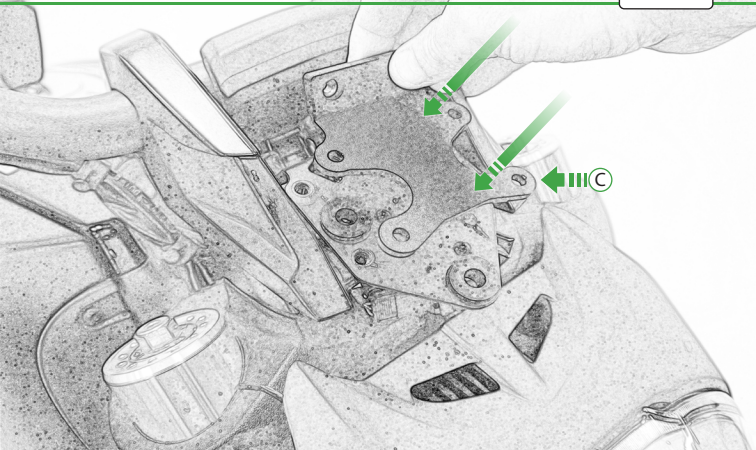



← OEM PART

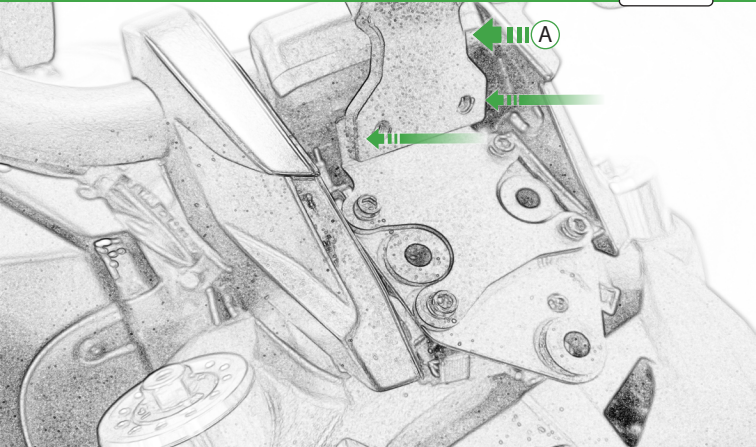

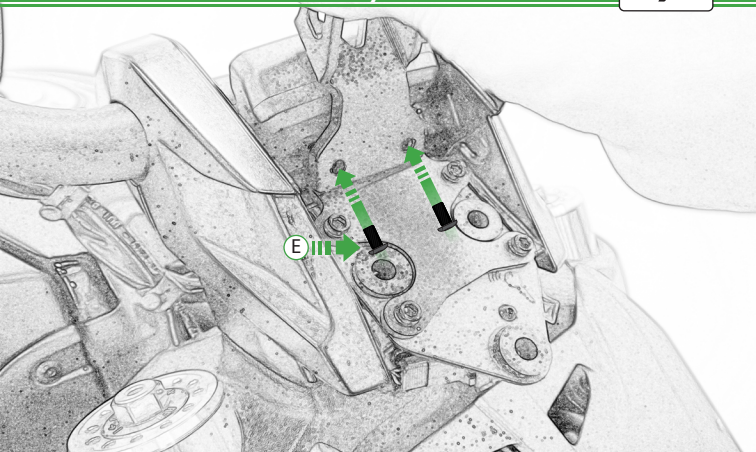

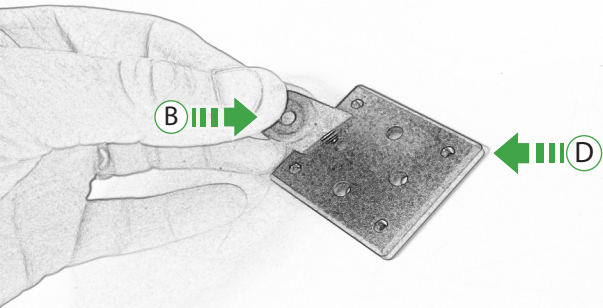

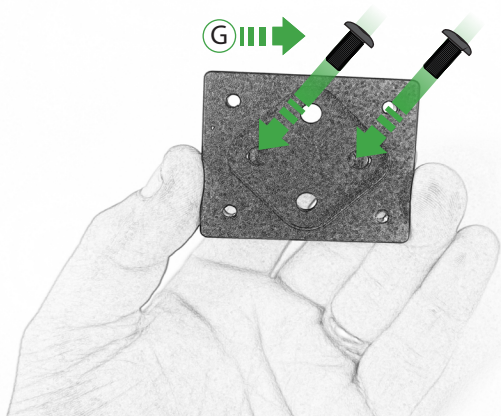





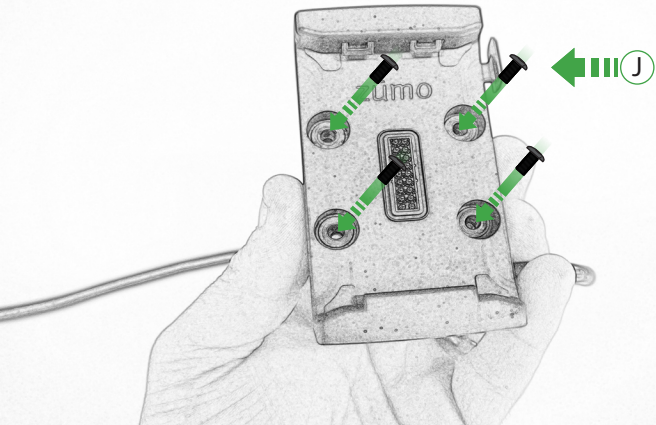

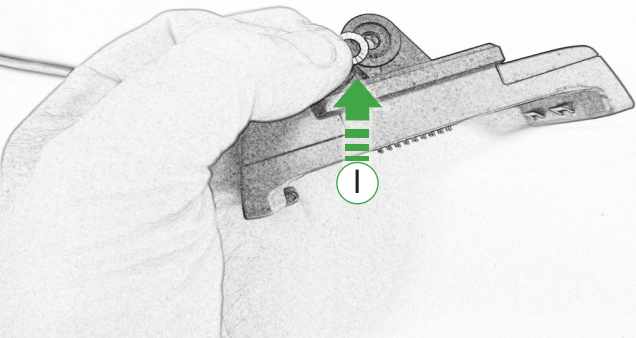

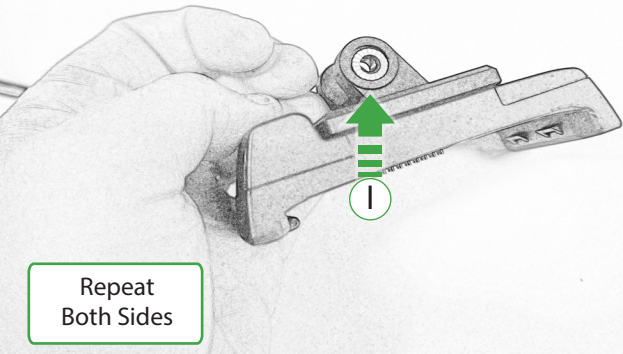

Repeat  
Both Sides

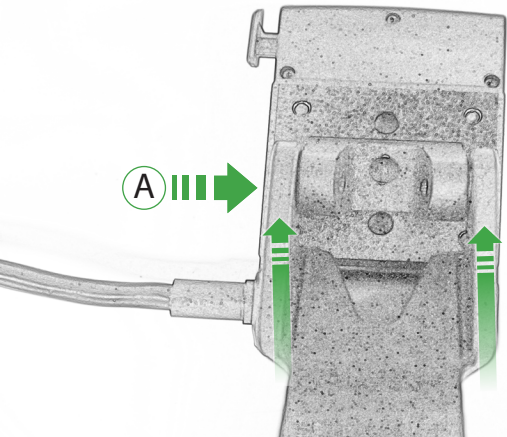

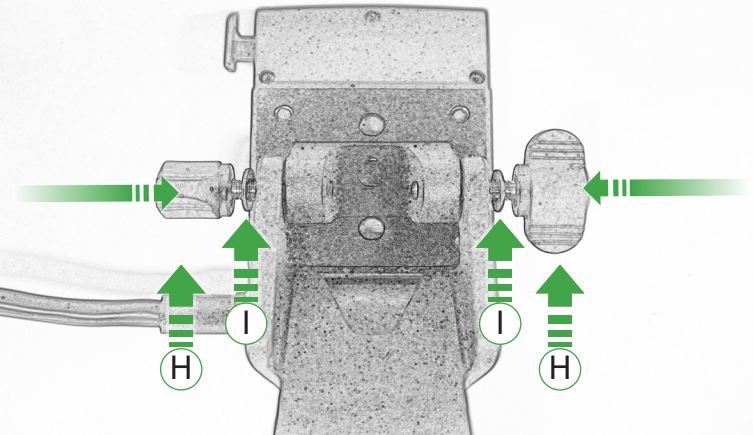

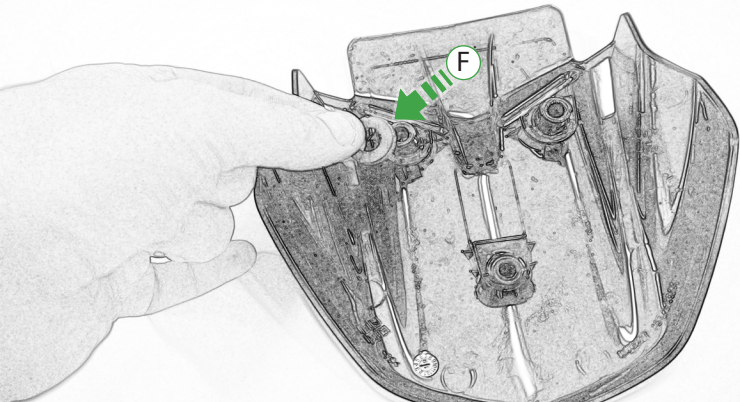

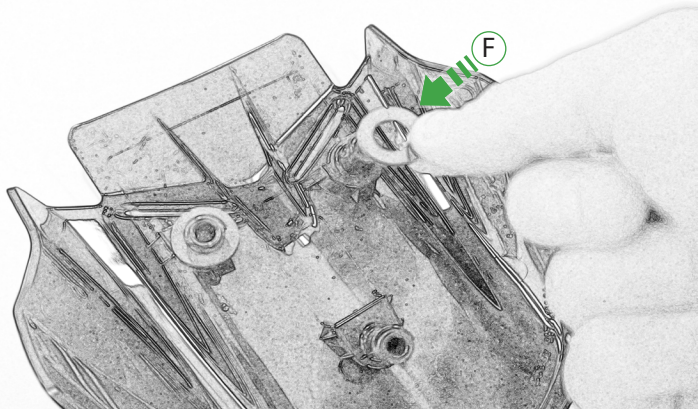

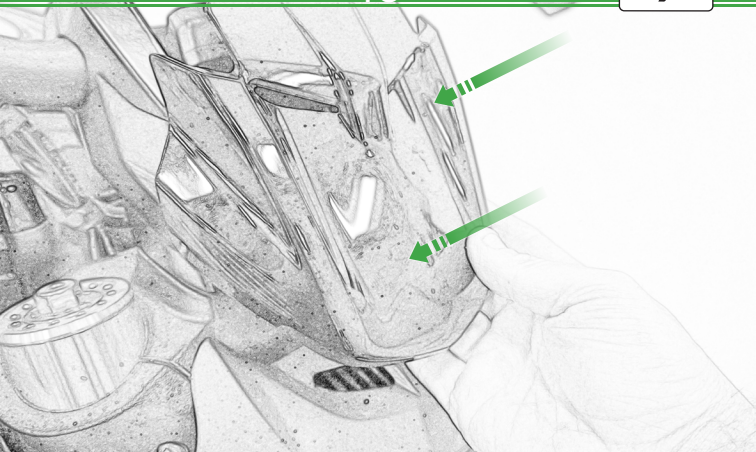



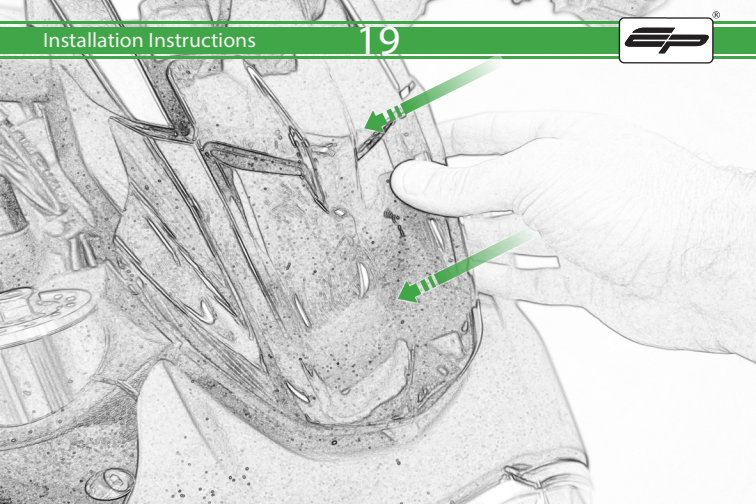



 **ESSENTIAL CHECKS** 

It is recommended that periodic inspections are made to ensure that all bolts are tightened to the specified torque settings.

Should the bike be involved in an accident a thorough inspection should be made and any components that have taken an impact, no matter how small, be replaced



**EVOTECH**®  
P E R F O R M A N C E

[www.evotech-performance.com](http://www.evotech-performance.com)